

FAIRVIEW™

DEFINING ARCHITECTURE SINCE 1983

vitrafix™

FAÇADE SYSTEM ACCESSORIES / BY FAIRVIEW

Weatherproofing

WALL SARK

WITH AS/NZS 42



vitrafix™

FAÇADE SYSTEM ACCESSORIES / BY FAIRVIEW

WALL SYSTEMS

CONTENTS

About	3
Rainscreen Systems	4
Clayton Terracotta Facade System	6
Smartbric Brick Facade System	16
Genesis & Genesis Signature Prefinished Compressed Fibre Cement Facade Systems	26
Vitradual Solid Aluminium Facade System	36
Vitracore G2 Engineered Aluminium Facade System	46
Stryüm Solid Aluminium Interlocking Facade System	56

ABOUT

In the ever-evolving field of construction, the demand for reliable and efficient building materials has led to the development of tested cladding systems. Fairview is dedicated to providing high-quality and high-performing facade systems that not only enhance the aesthetic appeal of buildings, but also adhere to the rigorous standards set by the construction code. By combining innovative design with technical excellence, Fairview ensures that each facade system is durable, sustainable and safe. This commitment guarantees a built environment that is not only visually striking, but also resilient and compliant, contributing to long-lasting structures that meet both functional and regulatory requirements.

The core advantage of a tested cladding system lies in its proven reliability. Fairview's integrated wall systems, including the cladding panels, insulation, sarking, sub-framing, fixings and accessories, are designed and tested as a complete unit. This ensures consistent performance and compliance with Australian building codes and standards, offering architects, engineers, builders and installers peace of mind that their structures will stand the test of time. Moreover, each component is subjected to extensive testing for factors such as thermal performance, moisture resistance and structural integrity. This level of scrutiny ensures that the cladding system not only enhances a building's energy efficiency, but also protects it from water ingress, wind damage and temperature fluctuations. As a result, Fairview's facade systems contribute to lower maintenance costs and extended lifespans for buildings, making them a wise investment for any construction project.

Incorporating Fairview's tested cladding systems into architectural designs opens up a world of creative possibilities. With a variety of materials available, ranging from sleek metal panels to earthy natural finishes, architects can achieve their desired aesthetic while ensuring compliance with safety and performance standards. As sustainability becomes increasingly important, Fairview has introduced cladding systems that are designed with eco-friendly materials and practices in mind, appealing to environmentally conscious clients. Ultimately, Fairview's facade systems not only enhance the visual appeal of a building, but also reinforce their resilience and functionality, making them an essential choice for modern architecture.

This manual details the tested facade systems available by Fairview.

RAINSCREEN SYSTEMS

As the world increasingly turns to more sustainably designed builds, Fairview is investing substantially in the development of rainscreen cladding systems for both our natural and metal product ranges.

Rainscreen facade is a two-level construction system which provides superior waterproofing, long term durability and thermal efficiency.

When rain and wind forces moisture towards the building, the majority is deflected off the outer layer of the facade, the primary weatherproof layer. The moisture that permeates the outer layer is then managed through ventilation and drainage in the cavity between the primary weatherproof layer and the secondary weatherproof layer. Rainscreen systems therefore utilise air flow and ventilation to insulate buildings and minimise exposure and damage caused by the elements.

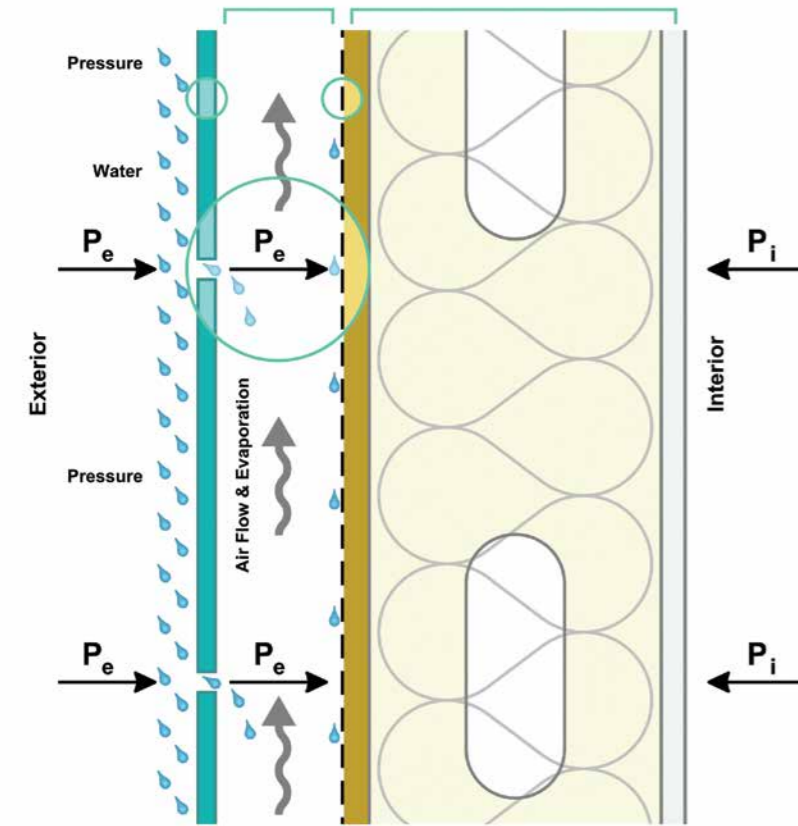

Drained, Back-Ventilated

Minimum amount of water reaches the AWB Barrier

Rainscreen facades combine an open cavity at the top and the bottom of the wall.

The top air cavity is protected with an overhang to minimise moisture entering.

Warmer air within the cavity rises and draws cooler air in from the base of the wall, helping the evaporative drying in the cavity for moisture and condensation control.

BENEFITS OF RAINSCREEN SYSTEMS

SUPERIOR WEATHERPROOFING:

Rainscreen facades protect the structure of the building from moisture, including rain and condensation, through a multi-layer barrier system, and is less prone to single failure point based on site workmanship.

Rainscreen facades minimise weatherproofing defects.

LONG TERM DURABILITY:

Rainscreen facades are less dependent on sealants, and hence are less subject to deterioration over time, and the maintenance cost of dealing with repairs.

CONDENSATION CONTROL:

When properly managed, condensation should form in the cladding cavity (as opposed to within the wall structure). A rainscreen provides for this to be drained or evaporated, thereby preventing damage and mould growth.

THERMAL EFFICIENCY:

A rainscreen facade helps shade the structure and dissipate heat. The heat, particularly from direct sunlight, is radiated into the cavity rather than being transferred directly into the structure. The warm air moves up and out the cavity by convection, drawing in cooler air at the base and insulating the primary wall structure.

CLAYTON TERRACOTTA FACADE SYSTEM

The Clayton Terracotta Facade System combines the charm of terracotta with modern production techniques. The result is a range of high-performing facade products that meet design and building requirements. Manufactured from clay, sculptured into shape and then fired at high temperatures, Clayton comes in a range of terracotta cladding textures and colours to offer warmth and a tactile sensation that is not achievable with other building products.

Clayton Terracotta Facade is offered with a proprietary sub-framing that has been tested for strength and durability and was locally engineered to suit Australian building requirements.

The Clayton installation system can be installed directly onto the subframe (e.g concrete, brick or stud wall), onto a top hat frame, or using a wall bracket and T-profile system that allows you to increase the wall cavity depth to allow for insulation or additional ventilation.

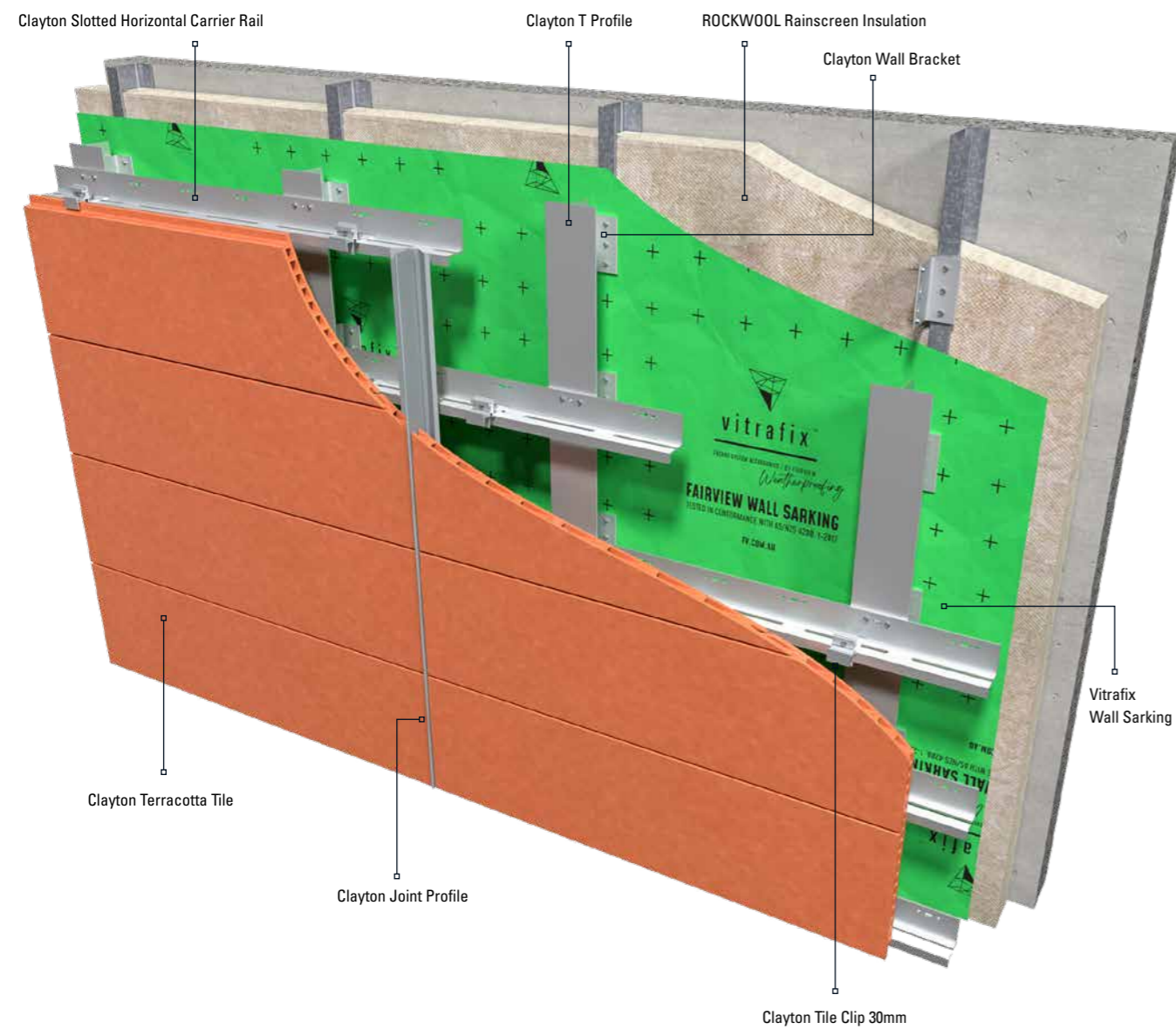

CLAYTON SUBSTRUCTURE

The substructure consists of aluminium profiles in the grade 6063 T6. Clayton is offered with three installation methods to greatly improve flexibility in design and installation efficiencies. These options include:



WALL BRACKET & T-PROFILE

The substructure consists of vertical T-profiles, anchored to the building with wall brackets. Clayton tiles are fixed by aluminium clips to the vertical profiles. This fixing method provides the maximum cavity depth allowing for insulation to be placed within the facade cavity.

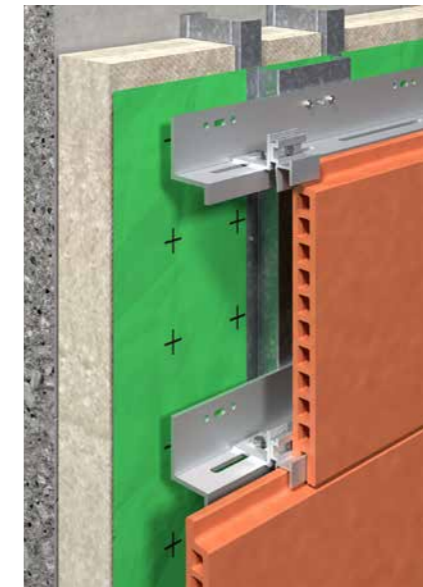

TOP HAT

The substructure consists of vertically mounted top hats installed at predetermined distances, depending on the loading requirements for the building. The vertical top hats permit the tile carrier to be fixed to the substructure allowing the terracotta tiles to be fixed onto the facade.

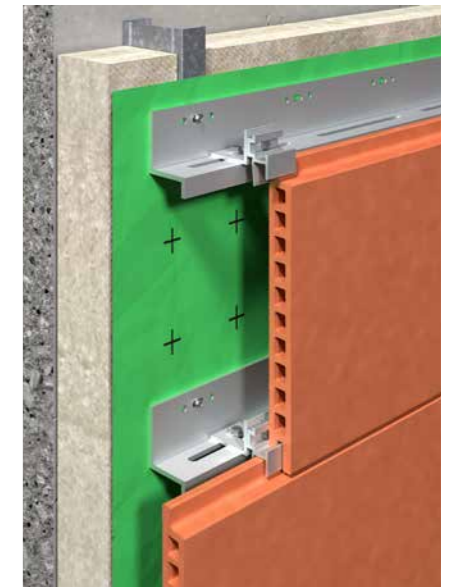

STUD WALL

The substructure consists of the tile carrier rail mounted directly onto the stud framing. This fixing method allows for the shallowest depth cavity, while the minimum use of sub-framing components speeds up the installation process and reduces the installation costs.



clayton™

TERRACOTTA FAÇADE SYSTEM / MANUFACTURED BY FAIRVIEW

CLAYTON TESTING AND COMPLIANCE

The Clayton Terracotta Facade System has undergone an intense local testing program and review by local consulting engineers to confirm durability and compliance to local requirements. This included:



AUSTRALIAN TEST STANDARD	TEST NAME
AS/NZS4456.10 / AS4046.7	Fired Clay Facade Units - Salt Attack
AS4456.6 & 13	Fired Clay Facade units Efflorescence and Lime Pitting
ISO10545.2	Tile Dimensions and Flatness
AZ/NZS4459.3	Water Absorption of Ceramic Tiles
AS1530.3	Simultaneous Determination of Ignitability, Flame Propagation, Heat Release and Smoke Release
FAR127 Terracotta Tile System NCC Compliance	Engineering Compliance Assessment to Australian Standards
-	Four-point loading test 18/30mm tiles
-	Sheer Loading Connection Test 18/30mm tiles

1. CONNECTION LOAD TESTING

Connection testing to confirm the strength between the terracotta tile and its mounting clip.

30MM TILE HORIZONTAL INSTALLATION

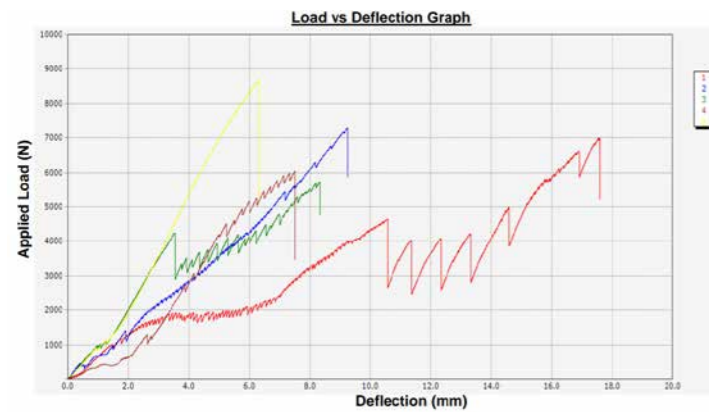

2. FOUR POINT LOAD TEST

Four Point Load Testing to confirm the breaking strength of the terracotta tile.

30MM TILE

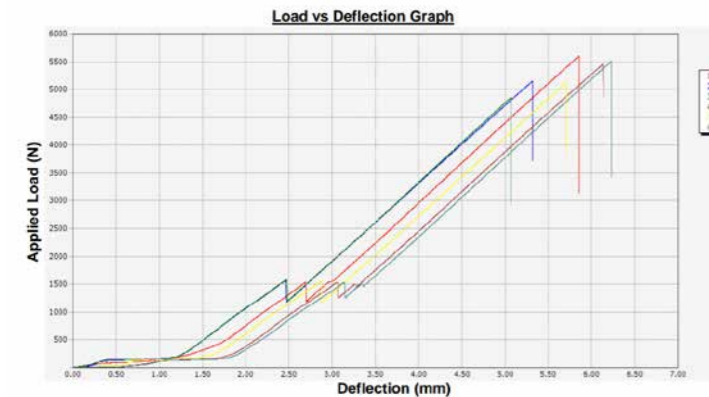

Contact the Fairview team for the full test report.

3. WALL SARKING

Clayton Terracotta Facade System is offered with the Fairview Vitrafix range of weatherproof membranes. Vitrafix Wall Sarking, Vitrafix Wall Sarking Ultra and Pro Clima Solitex Extasana have been tested to ensure compliance to the Building Code of Australia requirements.

BREATHABLE MEMBRANES DATA

		PROCLIMA SOLITEX EXTASANA	FAIRVIEW WALL SARKING VWS50	FAIRVIEW WALL SARKING ULTRA (REINFORCED) VWSU30
AS/NZS 4201.1-1994	Resistance to Dry Delamination	N/A	Pass	Pass
AS/NZS 4201.2-1994	Resistance to Wet Delamination	N/A	Pass	Pass
AS/NZS 4201.3-1994	Shrinkage	0.00%	0.002	0.002
AS1301.448s-2019	Tensile Strength - Mean (MD)	4.8 kN/m	4.3 kN/m	7.9 kN/m
	Tensile Strength - Mean (LD)	3.7 kN/m	2.7 kN/m	8.7 kN/m
ASNZS 4200.1-2017 Clause 5.3.2.3	Edge Tear Resistance - Mean (MD)	251N	210N	419 N
	Edge Tear Resistance - Mean (LD)	188N	140N	388 N
AS2001.2.19-1988	Bursting Force - Mean	>200N	258N	522N
AS/NZS 4201.5.1994	Emittance	NN	Non-Reflective	Non-Reflective
ASTM E96-2016	Water Vapour Transmission	Class 4	Class 4	Class 4
AS/NZS 4201.4-1994	Resistance to Water Penetration	Water Barrier (Pass)	Water Barrier (Pass)	Water Barrier (Pass)
AS/NZS 3100-2017	Surface Resistivity	Electrically Non-Cond.	Electrically Non-Cond.	Electrically Non-Cond.
AS 1530.2-1993	Flammability Index	<5	1 (Low)	4 (Low)
Thickness	Nominal Thickness	0.60mm	0.50mm	0.70mm
UV Resistance	Prior to being overclad	180 Days	3 months	6 months
Warranty		10 Years	12 years	15 years

4. ROCKWOOL INSULATION

ROCKWOOL Rainscreen is a stone wool insulation developed specifically for use within ventilated cladding systems. Fairview has selected a range of Rockwool insulation products to suit most building applications. This includes:



ROCKWOOL RAINSCREEN SL950/SL960 PRODUCT SPECIFICATION

R-VALUE M2K/W	THICKNESS (MM)	WIDTH (MM)	LENGTH (MM)	# PIECES PER PACK	AREA PER PACK (M2)
0.75	25	600	1200	12	4.32
1.45	50	600	1200	6	4.32
2.20	75	600	1200	4	2.16
2.95	100	600	1200	3	2.16

5. STEEL HAT OPTION

In order to ensure compliance and durability, the coil used to produce all Fairview Vitrafix Top Hats is tested in a NATA accredited test lab before being rolled into top hats. This testing confirms compliance to AS1397.

SAMPLE NO.	METALLIC COATING DESIGNATION	MEASURED SINGLE SPOT TOTAL COATING MASS BOTH SIDES [G/M ²]	AS 1397 TABLE 3.1 MIN. COATING MASS REQUIREMENT [G/M ²]	MEASURED BASE METAL THICKNESS [MM]	AS/NZS 1365 TABLE 5.1 THICKNESS TOLERANCES [MM]
1	Z275	310	250	1.14	1.15 ± 0.05
2	Z275	310	250	1.15	1.15 ± 0.05
3	Z275	265	250	1.14	1.15 ± 0.05
4	Z275	265	250	1.14	1.15 ± 0.05
5	Z275	255	250	1.14	1.15 ± 0.05
6	Z275	270	250	1.14	1.15 ± 0.05

Note: Coating mass rounded to 5 g/m², as per AS 1397:2021





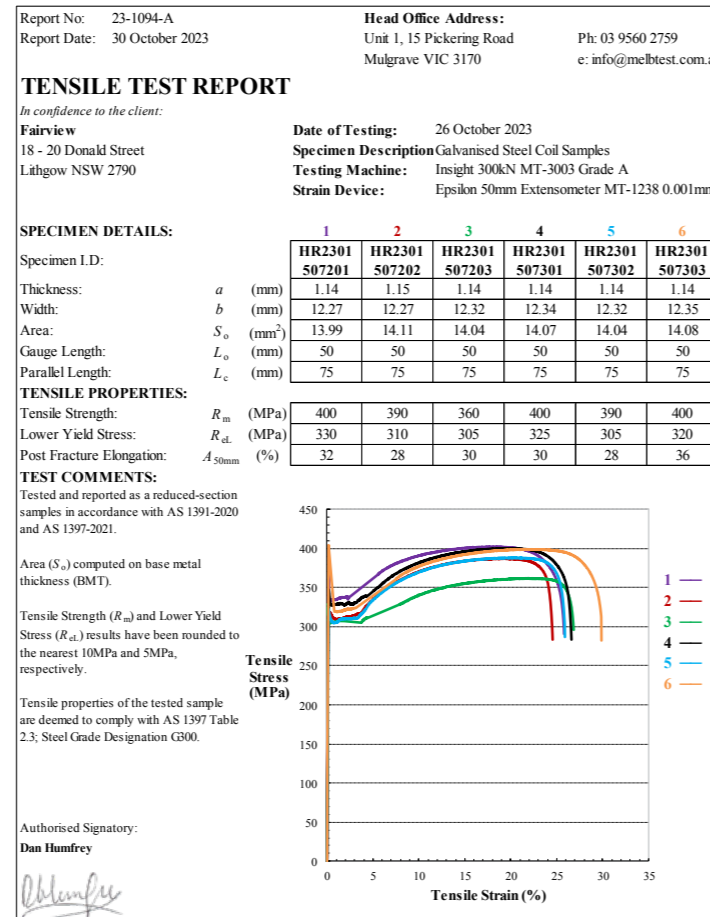

Vitrafix 35mm Galvanised Steel Perforated Top Hat

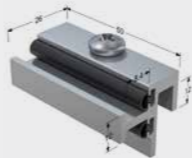

CLAYTON TERRACOTTA FACADE SYSTEM COMPONENT LIST

The Clayton Terracotta Facade System has been designed for durability, strength and performance. In line with this, the sub-framing components used for Clayton are either structural grade extruded aluminium or stainless steel, offering the highest performance against environmental conditions.





SUB-FRAMING ACCESSORIES

	NAME	DESCRIPTION	UNIT QUANTITY
	Clayton Terracotta Tile	Clayton Terracotta Facade tiles are available in various profiles and sizes.	1
	Clayton 18mm Horizontal Clip	Used as the mounting clip to install the 18mm Clayton terracotta tile. Grade: 6061 Temper: T5 Screw: S/S	1
	Clayton 18mm Horizontal Carrier Rail	Used as the carrier rail to install the 18mm Clayton terracotta tile. Grade: 6061 Temper: T5	1
	Clayton 30mm Tile T-Profile 5.8m	Used in conjunction with the Clayton 30mm terracotta tile wall bracket to install the carrier rail. Allows for a deeper cavity in order to install insulation within the cavity. Grade: 6061 Temper: T5	1
	Clayton 30mm Tile Wall Bracket	Used in conjunction with the Clayton 30mm Tile T-Profile to install the carrier rail. Allows for a deeper cavity in order to install insulation within the cavity. Grade: 6061 Temper: T5	1
	Clayton 30mm Tile Carrier Rail 5.8m	Used as the carrier rail that supports the Clayton 30mm Tile Clips.	Grade: 6061 Temper: T5

SUB-FRAMING ACCESSORIES

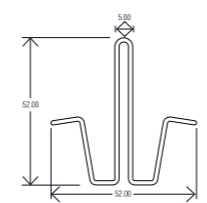
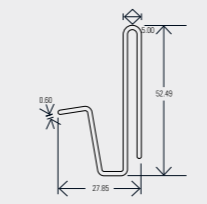
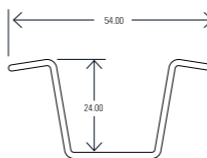
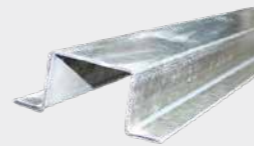
NAME	DESCRIPTION	UNIT QUANTITY
 <p>Clayton 30mm Tile Horizontal Top & Bottom Clip</p>	Used as the mounting clip to install the 30mm Clayton terracotta tile in a horizontal orientation. Grade: 6061 Temper: T5 Bolt/washer/nut: S/S	1
 <p>Clayton 30mm Tile Intermediate Horizontal Clip</p>	Used as the mounting clip to install the 30mm Clayton terracotta tile in a horizontal orientation. Grade: 6061 Temper: T5 Bolt/washer/nut: S/S	1
 <p>Clayton Joint Profile</p>	Used in the vertical joints between the terracotta tiles. Grade: 3003 Temper: H24 Thickness: 0.5mm	LM
 <p>Clayton 30mm Tile Intermediate Vertical Clip</p>	Used as the mounting clip to install the 30mm Clayton terracotta tile in a Vertical orientation. Grade: 6061 Temper: T5 Bolt/washer/nut: S/S	1

SUB-FRAMING ACCESSORIES



CODE	NAME	DESCRIPTION	UNIT QUANTITY
	 <p>Clayton Joint Profile</p>	Used in the vertical joints between the terracotta tiles. Grade: 3003 Temper: H24 Thickness: 0.5mm	LM
	 <p>Clayton Joint Abutment Profile</p>	Used in the vertical joints between the terracotta tile and wall. Grade: 3003 Temper: H24 Thickness: 0.5mm	LM
	 <p>Clayton Spring Profile</p>	Used in the cavity behind the Clayton terracotta cladding to tension the tiles and limit movement at the ends of the wall. Grade: 3003 Temper: H24 Thickness: 0.5mm	LM
T5035S	 <p>35mm Steel Top Hat 2.9m</p>	Galvanised Top Hat used as cladding substrate. Grade: G2 Steel Coating: Z 275 Thickness: 1.15BMT	1
T5035L	 <p>35mm Steel Top Hat 5.8m</p>	Galvanised Top Hat used as cladding substrate. Grade: G2 Steel Coating: Z 275 Thickness: 1.15BMT	1
T5035PS	 <p>35mm Steel Top Hat Perforated 2.9m</p>	Galvanised Top Hat used as cladding substrate. Grade: G2 Steel Coating: Z 275 Thickness: 1.15BMT	1
T5035PL	 <p>35mm Steel Top Hat Perforated 5.8m</p>	Galvanised Top Hat used as cladding substrate. Grade: G2 Steel Coating: Z 275 Thickness: 1.15BMT	1

MEMBRANES

	CODE	NAME	DESCRIPTION	UNIT QUANTITY
	VWS50	Vitrafix Wall Sarking 1500mm x 50m Roll	Vitrafix Wall Sarking is a Class 4 vapour permeable membrane and an effective water barrier. With a 12-year warranty, it can withstand direct UV exposure for up to 3 months.	1 Roll
	VWSU30	Vitrafix Wall Sarking Ultra 1500mm x 30m Roll	Vitrafix Wall Sarking Ultra is a Class 4, heavy duty vapour permeable membrane and an effective water barrier. With a 15-year warranty, it can withstand direct UV exposure for up to 6 months and has superior strength characteristics for high wind zones.	1 Roll
	MSE150	Pro Clima Solitex Extasana Wall Membrane - 150	Pro Clima Solitex Extasana Wall Membrane is a high performance, monolithic nonporous membrane. Can be exposed to the elements for 90 days. 55m ² per roll.	1
	VWST25	Vitrafix Sarking Tape 60mm x 25m Roll	Vitrafix Sarking Tape is used for sealing overlapping joints and areas where water ingress may occur.	1 Roll
	VWSTD100	Vitrafix Double Sided Sarking Tape 60mm x 100m	Vitrafix Double Sided Sarking Tape is used to temporarily fix sarking to framing prior to installation of the facade.	1 Roll
	MTE60	Pro Clima Weathertight Sealing Tape – Tescon Extora 60mm	Weathertight Sealing Tape used to seal Pro Clima membrane. Easy to cut, thin and flexible, can be applied to cold and wet surfaces, highly UV stabilised.	10
	MTEP60	Pro Clima Corner Tape – Tescon Extora Profil 60mm	Split release paper for corner of window/door installations. Thin and flexible, can be applied to cold and wet surfaces, highly UV stabilised.	5
	MTES150	Pro Clima Sill Tape – Tescon Extoseal 150mm	Pro Clima Sill Tape - Tescon Extoseal is a one-piece stretchable sill tape, no need for corner moulds, can be applied to damp surfaces, very high adhesion on cold surfaces, no heating necessary, highly UV stabilised.	2
	VWSEPDMS	Vitrafix EPDM Sleeve – Custom	EPDM Sleeve is used to weatherproof areas where a fixture, such as a pipe etc, penetrates the sarking material. Custom sizes are available, contact the Fairview team with specific size requirements.	Please contact the Fairview team for more details

*The use of these accessories needs to be checked for compliance on your project

INSULATION

	CODE	PRODUCT	R-VALUE (M2K/W) ROUNDED TO 0.05	THICKNESS (MM)	DENSITY (KG/M3)	PACK M2	PACKS/PALLET
	RSS3502512	ROCKWOOL™ Safe'n'Silent Pro350 1200 x 600 x 25mm 12/PAC	0.70	25	60	8.64	12
	RSS350506	ROCKWOOL™ Safe'n'Silent Pro350 1200 x 600 x 50mm 6/PAC	1.45	50	60	4.32	12
	RSS350754	ROCKWOOL™ Safe'n'Silent Pro350 1200 x 600 x 75mm 4/PAC	2.15	75	60	2.88	12
	RSS3501003	ROCKWOOL™ Safe'n'Silent Pro350 1200 x 600 x 100mm 3/PAC	2.85	100	60	2.16	12
	RRS9502512	ROCKWOOL™ Rainscreen SL950 1200 x 600 x 25mm 12/PAC	0.70	25	80	8.64	12
	RRS950388	ROCKWOOL™ Rainscreen SL950 1200 x 600 x 38mm 8/PAC	1.10	38	80	5.76	12
	RRS950506	ROCKWOOL™ Rainscreen SL950 1200 x 600 x 50mm 6/PAC	1.45	50	80	4.32	12
	RRS950754	ROCKWOOL™ Rainscreen SL950 1200 x 600 x 75mm 4/PAC	2.15	75	80	2.88	12
	RRS9501003	ROCKWOOL™ Rainscreen SL950 1200 x 600 x 100mm 3/PAC	2.85	100	80	2.16	12

OTHER SIZES/THICKNESSES ARE AVAILABLE ON REQUEST. PLEASE CONTACT THE FAIRVIEW TEAM FOR MORE INFORMATION

SMARTBRIC BRICK FACADE SYSTEM

Smartbric by Fairview is an innovative Ventilated Rainscreen Brick Facade System which ingeniously incorporates the option of a grouted Classic brick facing or a modern Rapid mortar-less brick facing in combination with either a unique mounting track or universal rail option to deliver a versatile natural looking masonry facade solution.

The Smartbric Classic and Rapid brick facings are secured into position using dual locking mechanism capturing both the top and bottom of the brick facing unit. Smartbric Classic is designed to be finished off using a mortar to deliver a flush finish brick look whereas the Smartbric Rapid is designed as a mortar-less system. The Rapid brick's recessed edges provide a shadow effect that replicated the look and character of brickwork with a raked joint. Smartbric Rapid can also be grouted if desired.

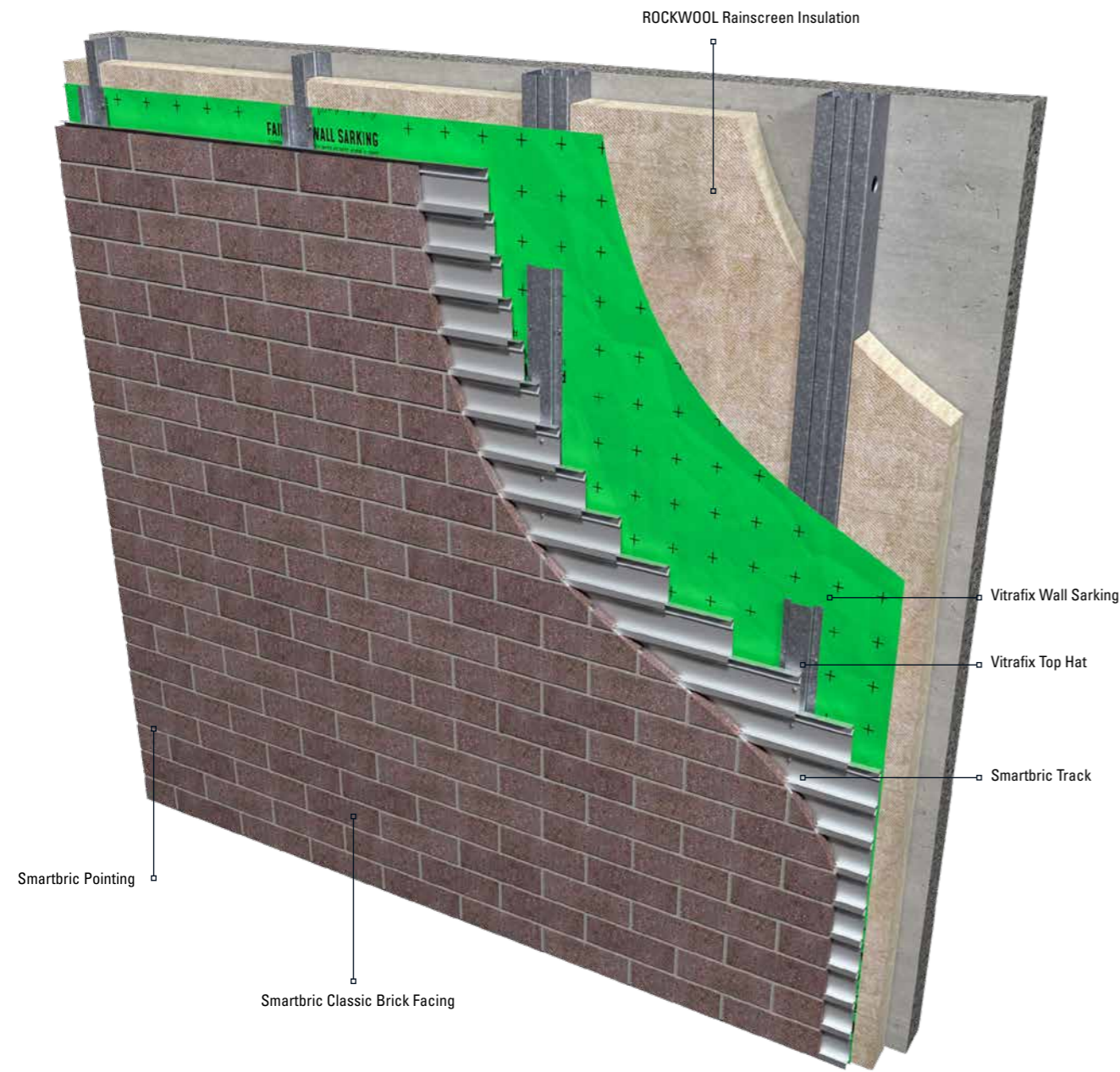

smartbric®

BRICK RAINSCREEN FAÇADE SYSTEM / MANUFACTURED BY FAIRVIEW

SMARTBRIC SYSTEM COMPONENTS

Brick facings are made from genuine brick cuttings or specially manufactured and profiled fired clay which when installed deliver the genuine appearance, colour and texture of a real clay brick wall.



25MM RAPID BRICK FACING



25MM CLASSIC BRICK FACING

SMARTBRIC INSTALLATION OPTIONS

Smartbric is available in two installation options which maximise installation efficiency.



TRACK

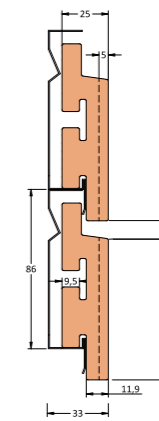

RAPID BRICK FACING

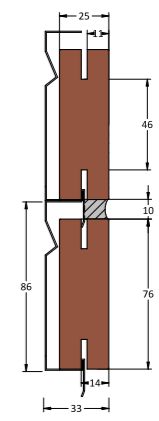

CLASSIC BRICK FACING



RAIL

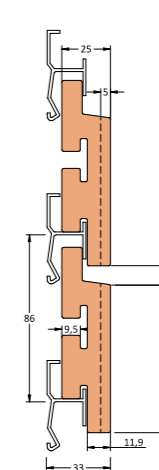

RAPID BRICK FACING

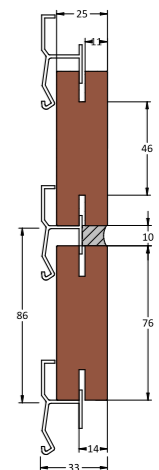

CLASSIC BRICK FACING

The Track and Rail installation options can be used together to create a universal Track and Rail mounting eco-system, allowing for a highly customisable solution and mix and match approach.

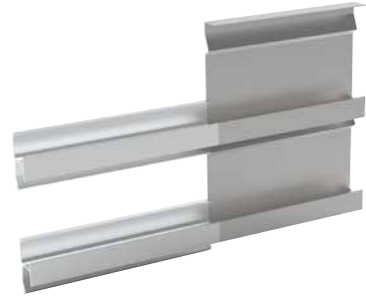

SMARTBRIC TESTING AND COMPLIANCE

Smartbric has undergone an intensive local testing program and review by local consulting engineers to confirm durability and compliance to local requirements. This included:



AUSTRALIAN TEST STANDARD	TEST NAME
NCC Volume One B1D4 and ABCB Housing Provisions 2.2.4	Determination of structural resistance of materials and forms of construction, for actions determined in accordance with NCC Volume One B1D3 and ABCB Housing Provisions 2.2.3
NCC Volume One F3P1 and Volume Two H2P2	Weatherproofing
AS/NZS 1170.1	Structural Design Actions Part 1
AS/NZS 1170.2	Structural Design Actions – Wind Actions
AS 1562.1	Design and Installation of Sheet Roof and Wall Cladding - Metal
AS/NZS 4284	Testing of Building Facades
AS 4055	Wind Loads for Housing

1. TRACK/RAIL

Smartbric Rail is engineered for enhanced durability and performance, available in either G200 and Z275 galvanized steel or high-quality aluminium. Smartbric is able to meet requirements of various applications.

The G200 and Z275 galvanized steel options offer superior corrosion resistance, ensuring a long-lasting solution in environments prone to moisture and harsh conditions. Alternatively, the aluminium Rail provides an even higher level of performance in corrosive environments. Together, these materials make Smartbric Rail an ideal choice for applications where longevity and resistance to the elements are critical.

2. SMARTBRIC REDI-MIX POINTING MORTAR



Smartbric Redi-Mix Polymer Modified Flexible Mortar was developed and tested as a pointing mortar for the Smartbric Ventilated Rainscreen Brick Facade System. Tested to AS4284-2008: Testing of building facades, the pre-mixed polymer modified mortar provides excellent bond and weather exposure performance.

Smartbric Redi-Mix provides an authentic mortar pointing look without the shortcomings or restraints of traditional mortars. The polymer modified formulation ensures consistency, ease of use and good workability.

Smartbric Redi-Mix Flexible Pointing Mortar is a synthetic mortar specially developed for brick masonry pointing. It has excellent mortar texture and fatigue loading characteristics after conditioning by prolonged water saturation (as per Australian Standard AS4046.8- 2015).

Once cured, Smartbric Redi-Mix Flexible Pointing Mortar forms an incredibly strong and durable bond between the masonry units and excellent adhesion to the metallic Track or Rail framing system.

3. WALL SARKING

Smartbric Ventilated Rainscreen Brick Facade System is offered with the Fairview Vitrafix range of weatherproof membranes. Vitrafix Wall Sarking, Vitrafix Wall Sarking Ultra and Pro Clima Solitex Extasana have been tested to ensure compliance to the Building Code of Australia Requirements.

BREATHABLE MEMBRANES DATA

		PROCLIMA SOLITEX EXTASANA	FAIRVIEW WALL SARKING VWS50	FAIRVIEW WALL SARKING ULTRA [REINFORCED] VWSU30
AS/NZS 4201.1-1994	Resistance to Dry Delamination	N/A	Pass	Pass
AS/NZS 4201.2-1994	Resistance to Wet Delamination	N/A	Pass	Pass
AS/NZS 4201.3-1994	Shrinkage	0.00%	0.002	0.002
AS1301.448s-2019	Tensile Strength - Mean (MD)	4.8 kN/m	4.3 kN/m	7.9 kN/m
	Tensile Strength - Mean (LD)	3.7 kN/m	2.7 kN/m	8.7 kN/m
ASNZS 4200.1-2017 Clause 5.3.2.3	Edge Tear Resistance - Mean (MD)	251N	210N	419 N
	Edge Tear Resistance - Mean (LD)	188N	140N	388 N
AS2001.2.19-1988	Bursting Force - Mean	>200N	258N	522N
AS/NZS 4201.5.1994	Emittance	NN	Non-Reflective	Non-Reflective
ASTM E96-2016	Water Vapour Transmission	Class 4	Class 4	Class 4
AS/NZS 4201.4-1994	Resistance to Water Penetration	Water Barrier (Pass)	Water Barrier (Pass)	Water Barrier (Pass)
AS/NZS 3100-2017	Surface Resistivity	Electrically Non-Cond.	Electrically Non-Cond.	Electrically Non-Cond.
AS 1530.2-1993	Flammability Index	<5	1 (Low)	4 (Low)
Thickness	Nominal Thickness	0.60mm	0.50mm	0.70mm
UV Resistance	Prior to being overclad	180 Days	3 months	6 months
Warranty		10 years	12 years	15 years

4. ROCKWOOL INSULATION

ROCKWOOL Rainscreen is a stone wool insulation developed specifically for use within ventilated cladding systems. Fairview has selected a range of Rockwool insulation products to suit most building applications. This includes:



ROCKWOOL RAINSCREEN SL950/SL960 PRODUCT SPECIFICATION

R-VALUE M2K/W	THICKNESS (MM)	WIDTH (MM)	LENGTH (MM)	# PIECES PER PACK	AREA PER PACK (M2)
0.75	25	600	1200	12	4.32
1.45	50	600	1200	6	4.32
2.20	75	600	1200	4	2.16
2.95	100	600	1200	3	2.16

SMARTBRIC BRICK FACADE SYSTEM COMPONENT LIST





SUB-FRAMING ACCESSORIES

NAME	CODE	DESCRIPTION	UNIT QUANTITY
Smartbric Track 2.4m	SBTR1000	GAL Z275	LM
	SBTR2000	GAL Z450	
	SBTR0010	Magnaflow:	
	SBTR0011	Offwhite	
	SBTR0012	Monolith	
	SBTR0013	Gull Grey	
	SBTR0014	Birch	
Smartbric Track 3m	SBTR1100	GAL Z275	LM
	SBTR2100	GAL Z450	
	SBTR0110	Magnaflow:	
	SBTR0111	Offwhite	
	SBTR0112	Monolith	
	SBTR0113	Gull Grey	
	SBTR0114	Birch	
Smartbric Track 4m	SBTR1200	GAL Z275	LM
	SBTR2200	GAL Z450	
	SBTR0210	Magnaflow:	
	SBTR0211	Offwhite	
	SBTR0212	Monolith	
	SBTR0213	Gull Grey	
	SBTR0214	Birch	
Smartbric Track 4m	SBTR0215	Wallaroo	LM
	SBTR0216	Armour Grey	
		Armour Grey	
		Slate Grey	

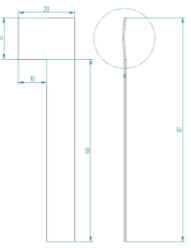

SUB-FRAMING ACCESSORIES

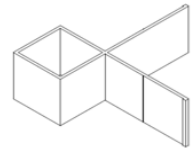
NAME	CODE	DESCRIPTION	UNIT QUANTITY
Smartbric Track Creeper 2.4m	SBTRC1000	GAL Z275	LM
	SBTRC2000	GAL Z450	
	SBTRC0010	Magnaflow:	
	SBTRC0011	Offwhite	
	SBTRC0012	Monolith	
	SBTRC0013	Gull Grey	
	SBTRC0014	Birch	
Smartbric Track Creeper 3m	SBTRC1100	GAL Z275	LM
	SBTRC2100	GAL Z450	
	SBTRC0110	Magnaflow:	
	SBTRC0111	Offwhite	
	SBTRC0112	Monolith	
	SBTRC0113	Gull Grey	
	SBTRC0114	Birch	
Smartbric Track Creeper 4m	SBTRC1200	GAL Z275	LM
	SBTRC2200	GAL Z450	
	SBTRC0210	Magnaflow:	
	SBTRC0211	Offwhite	
	SBTRC0212	Monolith	
	SBTRC0213	Gull Grey	
	SBTRC0214	Birch	
Smartbric Rail 6.5m	SBTRC0215	Wallaroo	LM
	SBTRC0216	Armour Grey	
		Armour Grey	
		Slate Grey	
Smartbric Rail 6.5m	SBRA0000	Mill	LM
	SBRA1111	Custom	
Smartbric Top Rail 6.5m	SBTR0000	Mill	LM
	SBTR0001	Black	
	SBTR0002	White	
	SBTR0003	Offwhite	
Smartbric Bottom Rail 6.5m	SBTR1111	Custom	LM
	SBBR0000	Mill	
	SBBR0001	Black	
	SBBR0002	White	
Smartbric Bottom Rail 6.5m	SBBR0003	Offwhite	LM
	SBBR1111	Custom	
		Custom	

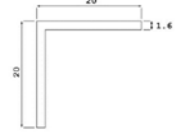
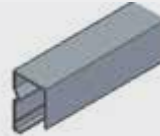

SUB-FRAMING ACCESSORIES

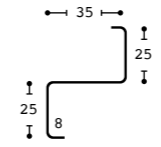
	NAME	CODE	DESCRIPTION	UNIT QUANTITY
	Smartbric Spacer	CBSP1000	Unizinc Magnaflow: Offwhite Monolith Gull Grey Birch Wallaroo Armour Grey Slate Grey	1
		SBSP0010		
		SBSP0011		
		SBSP0012		
		SBSP0013		
		SBSP0014		
		SBSP0015		
	SBSP0016			
	Smartbric Joiner	SBJO0010	Unizinc Magnaflow: Offwhite Monolith Gull Grey Birch Wallaroo Armour Grey Slate Grey	1
		SBJO0011		
		SBJO0012		
		SBJO0013		
		SBJO0014		
		SBJO0015		
		SBJO0016		
	Smartbric External Angle 6.5m	SBEA0000	Mill Black White Offwhite Custom	LM
		SBEA0001		
		SBEA0002		
		SBEA0003		
		SBEA1111		
	Smartbric Internal Rail 6.5m	SBIA0000	Mill Black White Offwhite Custom	LM
		SBIA0001		
		SBIA0002		
		SBIA0003		
		SBIA1111		
	Smartbric Angle 6.5m 20 x 20 x 1.6	SBA0000	Mill Black White Offwhite Custom	LM
		SBA0001		
		SBA0002		
		SBA0003		
		SBA1111		
	Smartbric J-Mould	SBJM0000	Mill Black White Offwhite Custom	LM
		SBJM0001		
		SBJM0002		
		SBJM0003		
		SBJM1111		

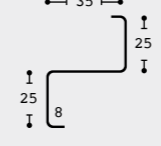
SUB-FRAMING ACCESSORIES

	NAME	CODE	DESCRIPTION	UNIT QUANTITY
	35mm Steel S Batten Perforated 2.9m	S2535PS	S Batten serves as a steel substrate for the Stryum Linear panels. The new S Batten perforated side wall keeps cavity ventilated and prevents moisture pooling in horizontal application. Linear Panel Grade: G550 Thickness: 1.15 BMT Coating: Z275	1
	S Batten - Ø20mm holes with 110mm centrespacings			
	35mm Steel S Batten Perforated 5.8m	S2535PL	S Batten serves as a steel substrate for the Stryum Linear panels. The new S Batten perforated side wall keeps cavity ventilated and prevents moisture pooling in horizontal application. Linear Panel Grade: G550 Thickness: 1.15 BMT Coating: Z275	1
	S Batten - Ø20mm holes with 110mm centrespacings			

MORTAR



	NAME	CODE	DESCRIPTION	UNIT QUANTITY
	Smartbric Add-mix	SBAM0000	Neutral	1
	Smartbric Redi-mix	SBR0001 SBR0002 SBR0003	Neutral Oatmeal Grey	1

MEMBRANES

	CODE	NAME	DESCRIPTION	UNIT QUANTITY
	VWS50	Vitrafix Wall Sarking 1500mm x 50m Roll	Vitrafix Wall Sarking is a Class 4 vapour permeable membrane and an effective water barrier. With a 12-year warranty, it can withstand direct UV exposure for up to 3 months.	1 Roll
	VWSU30	Vitrafix Wall Sarking Ultra 1500mm x 30m Roll	Vitrafix Wall Sarking Ultra is a Class 4, heavy duty vapour permeable membrane and an effective water barrier. With a 15-year warranty, it can withstand direct UV exposure for up to 6 months and has superior strength characteristics for high wind zones.	1 Roll
	MSE150	Pro Clima Solitex Extasana Wall Membrane - 150	Pro Clima Solitex Extasana Wall Membrane is a high performance, monolithic nonporous membrane. Can be exposed to the elements for 90 days. 55m ² per roll.	1
	VWST25	Vitrafix Sarking Tape 60mm x 25m Roll	Vitrafix Sarking Tape is used for sealing overlapping joints and areas where water ingress may occur.	1 Roll
	VWSTD100	Vitrafix Double Sided Sarking Tape 60mm x 100m	Vitrafix Double Sided Sarking Tape is used to temporarily fix sarking to framing prior to installation of the facade.	1 Roll
	MTE60	Pro Clima Weathertight Sealing Tape – Tescon Extora 60mm	Weathertight Sealing Tape used to seal Pro Clima membrane. Easy to cut, thin and flexible, can be applied to cold and wet surfaces, highly UV stabilised.	10
	MTEP60	Pro Clima Corner Tape – Tescon Extora Profil 60mm	Split release paper for corner of window/door installations. Thin and flexible, can be applied to cold and wet surfaces, highly UV stabilised.	5
	MTES150	Pro Clima Sill Tape – Tescon Extoseal 150mm	Pro Clima Sill Tape - Tescon Extoseal is a one-piece stretchable sill tape, no need for corner moulds, can be applied to damp surfaces, very high adhesion on cold surfaces, no heating necessary, highly UV stabilised.	2
	VWSEPDMS	Vitrafix EPDM Sleeve – Custom	EPDM Sleeve is used to weatherproof areas where a fixture, such as a pipe etc, penetrates the sarking material. Custom sizes are available, contact the Fairview team with specific size requirements.	Please contact the Fairview team for more details

*The use of these accessories needs to be checked for compliance on your project

INSULATION

	CODE	PRODUCT	R-VALUE (M ² K/W) ROUNDED TO 0.05	THICKNESS (MM)	DENSITY (KG/ M ³)	PACK M ²	PACKS/ PALLET
	RSS3502512	ROCKWOOL™ Safe'n'Silent Pro350 1200 x 600 x 25mm 12/PAC	0.70	25	60	8.64	12
	RSS350506	ROCKWOOL™ Safe'n'Silent Pro350 1200 x 600 x 50mm 6/PAC	1.45	50	60	4.32	12
	RSS350754	ROCKWOOL™ Safe'n'Silent Pro350 1200 x 600 x 75mm 4/PAC	2.15	75	60	2.88	12
	RSS3501003	ROCKWOOL™ Safe'n'Silent Pro350 1200 x 600 x 100mm 3/PAC	2.85	100	60	2.16	12
	RRS9502512	ROCKWOOL™ Rainscreen SL950 1200 x 600 x 25mm 12/PAC	0.70	25	80	8.64	12
	RRS950388	ROCKWOOL™ Rainscreen SL950 1200 x 600 x 38mm 8/PAC	1.10	38	80	5.76	12
	RRS950506	ROCKWOOL™ Rainscreen SL950 1200 x 600 x 50mm 6/PAC	1.45	50	80	4.32	12
	RRS950754	ROCKWOOL™ Rainscreen SL950 1200 x 600 x 75mm 4/PAC	2.15	75	80	2.88	12
	RRS9501003	ROCKWOOL™ Rainscreen SL950 1200 x 600 x 100mm 3/PAC	2.85	100	80	2.16	12

OTHER SIZES/THICKNESSES ARE AVAILABLE ON REQUEST. PLEASE CONTACT THE FAIRVIEW TEAM FOR MORE INFORMATION

GENESIS & GENESIS SIGNATURE PREFINISHED COMPRESSED FIBRE CEMENT FACADE SYSTEMS

Genesis and Genesis Signature are innovative prefinished compressed fibre cement facade solutions, designed to meet the highest standards of compliance with the National Construction Code (NCC). The comprehensive testing processes and certifications guarantee that Genesis exceeds all relevant compliance requirements providing architects, engineers and builders with confidence that their projects will be durable and lasting.

Genesis and Genesis Signature are sold as complete, fully integrated systems, which means they are not standalone products but part of a broader system that works in harmony to achieve compliance. This systemised approach simplifies the process for builders by offering an all-in-one solution, reducing the complexities of compliance across various stages of construction. With the full system approach, builders can ensure that every component, from materials to installation methods, is compatible and compliant with NCC standards, facilitating smoother approvals and inspections.

In addition to being tested for regulatory compliance, Genesis and Genesis Signature also undergo independent third-party review (CodeMark) to verify their performance and durability in real-world applications.

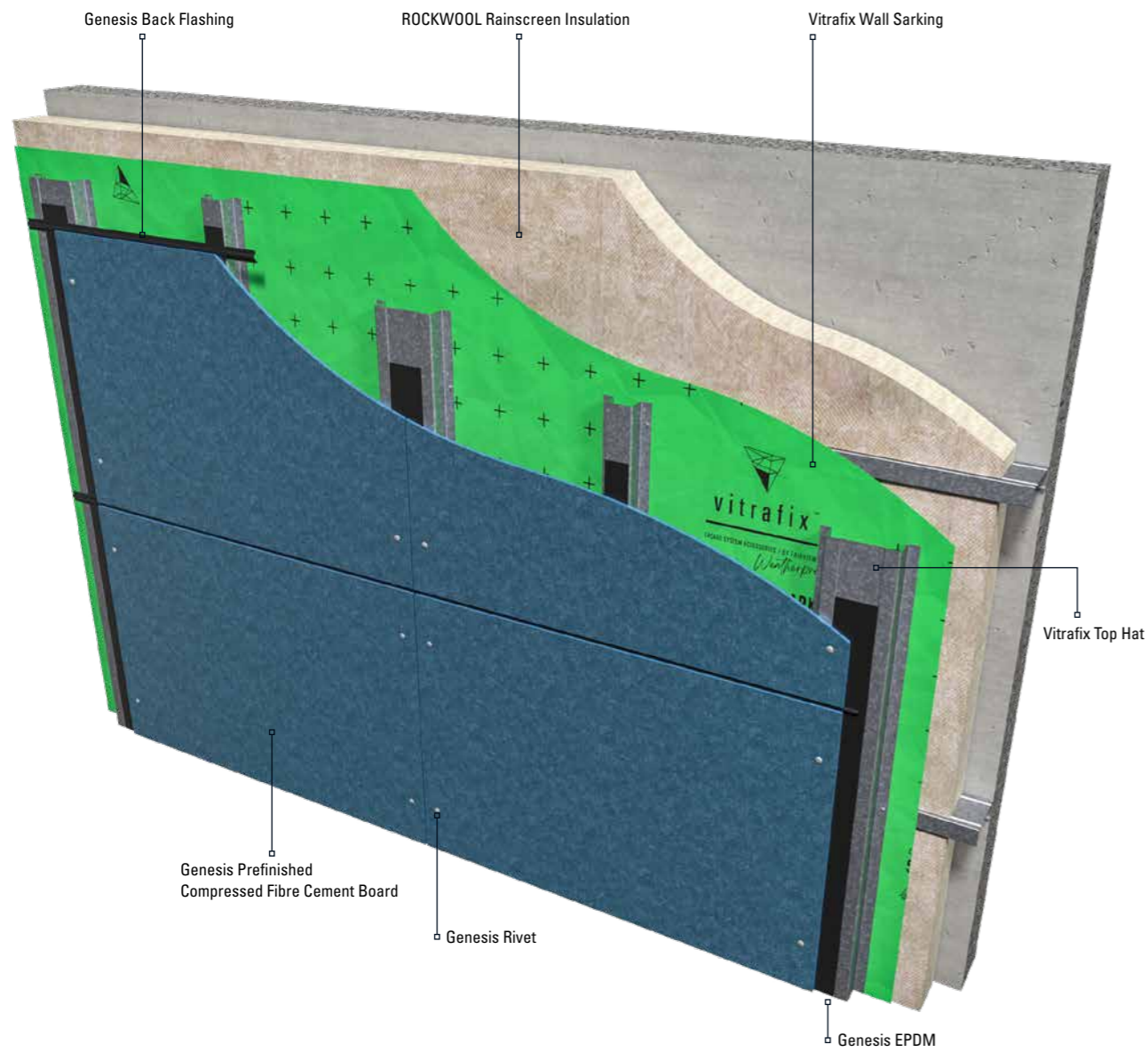

genesis[™]

PREFINISHED COMPRESSED FIBRE CEMENT / MANUFACTURED BY FAIRVIEW

Signature

genesis[™]

PREFINISHED COMPRESSED FIBRE CEMENT / MANUFACTURED BY FAIRVIEW

GENESIS TESTING AND COMPLIANCE

Fairview's Genesis and Genesis Signature prefinished compressed fibre cement facade systems have been intensively tested to ensure durability, strength and compliance to the Building Code of Australia. The following testing and compliance assessments have been completed for Genesis and Genesis Signature:

AUSTRALIAN TEST STANDARD	GENESIS	GENESIS SIGNATURE
CFC Panel Pull Out Test SFS TUF-S Concealed Anchors - DC Tech and Aluminium Extrusion	YES	
AS1530.3	YES	YES
AS4284	YES	YES
Group Number Assessment	YES	YES
Impact Testing	YES	YES
Bushfire Assessment	YES	YES
AS2908.2:2000 (ISO 8336) Cellulose-cement Products - Part 2 Compliance	YES	YES

1. IMPACT TESTING

With the facade being the primary protection against external forces, Genesis and Genesis Signature have been tested to ISO 7892:1998 in accordance with ETAG 034 to confirm durability and strength against impact.

TYPE OF IMPACT	TYPE OF BALL	MASS	ENERGY	HEIGHT	POSITION	OBSERVATION
5.4.4.1	Steel ball	0.5kg	1 Joule	0.20m	3 locations	No damage
	Steel ball	0.5kg	3 Joule	0.61m	3 locations	No damage
	Steel ball	1.0kg	10 Joule	1.02m	3 locations	No damage
5.4.4.2	Soft ball	3.0kg	10 Joule	0.34m	3 locations	No damage
	Soft ball	3.0kg	60 Joule	2.04m	3 locations	No damage
	Soft ball	50.0kg	300 Joule	0.61m	At least in the centre point	Broken, deterioration
	Soft ball	50.0kg	400 Joule	0.82m	At least in the centre point	Not tested

2. WALL SARKING

Genesis prefinished compressed fibre cement systems are offered with the Fairview Vitrafix range of weatherproof membranes. Vitrafix Wall Sarking, Vitrafix Wall Sarking Ultra and Pro Clima Solitex Extasana have been tested to ensure compliance to the Building Code of Australia requirements.

BREATHABLE MEMBRANES DATA

		PROCLIMA SOLITEX EXTASANA	FAIRVIEW WALL SARKING VWS50	FAIRVIEW WALL SARKING ULTRA (REINFORCED) VWSU30
AS/NZS 4201.1-1994	Resistance to Dry Delamination	N/A	Pass	Pass
AS/NZS 4201.2-1994	Resistance to Wet Delamination	N/A	Pass	Pass
AS/NZS 4201.3-1994	Shrinkage	0.00%	0.002	0.002
AS1301.448s-2019	Tensile Strength - Mean (MD)	4.8 kN/m	4.3 kN/m	7.9 kN/m
	Tensile Strength - Mean (LD)	3.7 kN/m	2.7 kN/m	8.7 kN/m
ASNZS 4200.1-2017 Clause 5.3.2.3	Edge Tear Resistance - Mean (MD)	251N	210N	419 N
	Edge Tear Resistance - Mean (LD)	188N	140N	388 N
AS2001.2.19-1988	Bursting Force - Mean	>200N	258N	522N
AS/NZS 4201.5.1994	Emittance	NN	Non-Reflective	Non-Reflective
ASTM E96-2016	Water Vapour Transmission	Class 4	Class 4	Class 4
AS/NZS 4201.4-1994	Resistance to Water Penetration	Water Barrier (Pass)	Water Barrier (Pass)	Water Barrier (Pass)
AS/NZS 3100-2017	Surface Resistivity	Electrically Non-Cond.	Electrically Non-Cond.	Electrically Non-Cond.
AS 1530.2-1993	Flammability Index	<5	1 (Low)	4 (Low)
Thickness	Nominal Thickness	0.60mm	0.50mm	0.70mm
UV Resistance	Prior to being overclad	180 Days	3 months	6 months
Warranty		10 years	12 years	15 years

3. ROCKWOOL INSULATION

ROCKWOOL Rainscreen is a stone wool insulation developed specifically for use within ventilated cladding systems. Fairview has selected a range of Rockwool insulation products to suit most building applications. This includes:



ROCKWOOL RAINSCREEN SL950/SL960 PRODUCT SPECIFICATION

R-VALUE M2K/W	THICKNESS [MM]	WIDTH [MM]	LENGTH [MM]	# PIECES PER PACK	AREA PER PACK [M2]
0.75	25	600	1200	12	4.32
1.45	50	600	1200	6	4.32
2.20	75	600	1200	4	2.16
2.95	100	600	1200	3	2.16

4. SUB-FRAMING TESTING FOR COMPLIANCE

In order to ensure compliance and durability, the coil used to produce all Fairview Vitrafix Top Hats is tested in a NATA accredited test lab before being rolled into top hats. This testing confirms compliance to AS1397.

SAMPLE NO.	METALLIC COATING DESIGNATION	MEASURED SINGLE SPOT TOTAL COATING MASS BOTH SIDES [G/M ²]	AS 1397 TABLE 3.1 MIN. COATING MASS REQUIREMENT [G/M ²]	MEASURED BASE METAL THICKNESS [MM]	AS/NZS 1365 TABLE 5.1 THICKNESS TOLERANCES [MM]
1	Z275	310	250	1.14	1.15 ± 0.05
2	Z275	310	250	1.15	1.15 ± 0.05
3	Z275	265	250	1.14	1.15 ± 0.05
4	Z275	265	250	1.14	1.15 ± 0.05
5	Z275	255	250	1.14	1.15 ± 0.05
6	Z275	270	250	1.14	1.15 ± 0.05

Note: Coating mass rounded to 5 g/m², as per AS 1397:2021



Vitrafix 35mm Galvanised Steel Perforated Top Hat

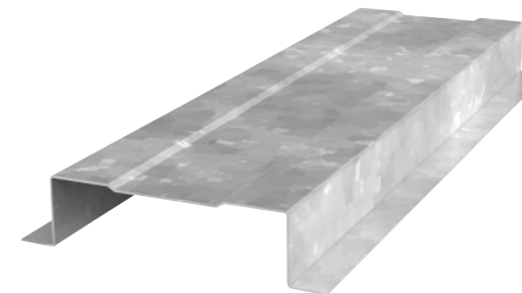

Vitrafix 120mm Galvanised Steel Top Hat

Report No: 23-1094-A
Report Date: 30 October 2023

Head Office Address:
Unit 1, 15 Pickering Road
Mulgrave VIC 3170

Ph: 03 9560 2759
e: info@mebttest.com.au

TENSILE TEST REPORT

In confidence to the client:

Fairview
18 - 20 Donald Street
Lithgow NSW 2790

Date of Testing: 26 October 2023
Specimen Description: Galvanised Steel Coil Samples
Testing Machine: Insight 300kN MT-3003 Grade A
Strain Device: Epsilon 50mm Extensometer MT-1238 0.001mm

SPECIMEN DETAILS:

	1	2	3	4	5	6
Specimen I.D:	HR2301 507201	HR2301 507202	HR2301 507203	HR2301 507301	HR2301 507302	HR2301 507303
Thickness:	a (mm) 1.14	1.15	1.14	1.14	1.14	1.14
Width:	b (mm) 12.27	12.27	12.32	12.34	12.32	12.35
Area:	S _o (mm ²) 13.99	14.11	14.04	14.07	14.04	14.08
Gauge Length:	L _o (mm) 50	50	50	50	50	50
Parallel Length:	L _c (mm) 75	75	75	75	75	75

TENSILE PROPERTIES:

	1	2	3	4	5	6
Tensile Strength:	R _m (MPa) 400	390	360	400	390	400
Lower Yield Stress:	R _{el} (MPa) 330	310	305	325	305	320
Post Fracture Elongation:	A _{50mm} (%) 32	28	30	30	28	36

TEST COMMENTS:
Tested and reported as a reduced-section samples in accordance with AS 1391-2020 and AS 1397-2021.

Area (S_o) computed on base metal thickness (BMT).

Tensile Strength (R_m) and Lower Yield Stress (R_{el}) results have been rounded to the nearest 10MPa and 5MPa, respectively.

Tensile properties of the tested sample are deemed to comply with AS 1397 Table 2.3; Steel Grade Designation G300.

Authorised Signatory:
Dan Humphrey

Stainless steel rivets are offered with Genesis and Genesis Signature due to their strength and durability. The rivets are colour coated to ensure a match to the Genesis facade board.

OPEN STAINLESS RIVET (STAINLESS MANDREL)

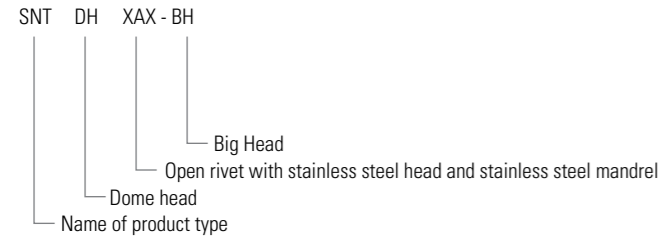

PRODUCT RANGE

DIAMETER D1 (MM)	LENGTH L (MM)	DRILL HOLE	HEAD DIAMETER D2 (MM)	HEAD HEIGHT K (MM)	LOAD CAPACITY TENSILE/SHEAR (N)
ø4.8	20	ø4.9	ø14.0	2.5	3700 / 3100

COMMITMENT TO QUALITY, THE ENVIRONMENT AND COMPLIANCE

Genesis and Genesis Signature have been engineered for quality, durability, environmental stewardship and compliance to local building requirements. This is evidenced by the industry-leading warranties, independent compliance certification and environmental credentials held by Genesis, making it the right choice for Australian building designs.









GENESIS PREFINISHED COMPRESSED FIBRE CEMENT FACADE SYSTEM COMPONENT LIST

SUB-FRAMING ACCESSORIES

	CODE	NAME	DESCRIPTION	UNIT QUANTITY
		Genesis & Genesis Signature Facade Board	Through-coloured, prefinished compressed fibre cement board. Width Length Thickness Standard 1250 2500 8 1250 3050 8	LM
		3.5mm Back Flashing 3m	Used as a weather seal for horizontal joints between Genesis boards. 3.5mm x 0.48 BMT	1
		Ventilated Profile	Used at the base of wall to exclude vermin and allow ventilation. Available as Small (50 x 30 x 2400mm); Medium (70 x 30 x 2400mm); and Large (100 x 30 x 2400mm). All profiles have a 4.5mm diameter perforated hole size.	1
	T12035S	120mm Steel Top Hat 2.9m	Designed to span vertically across the building structure to support the facade panels at vertical joints. Grade: G2 Steel Coating: Z 275 Thickness: 1.15BMT	1
	T12035L	120mm Steel Top Hat 5.8m	Designed to span vertically across the building structure to support the facade panels at vertical joints. Grade: G2 Steel Coating: Z 275 Thickness: 1.15BMT	1
	T5035S	35mm Steel Top Hat 2.9m	Metal top hat installed vertically for intermediate sheet support. Grade: G2 Steel Coating: Z 275 Thickness: 1.15BMT	1
	T5035L	35mm Steel Top Hat 5.8m	Metal top hat installed vertically for intermediate sheet support. Grade: G2 Steel Coating: Z 275 Thickness: 1.15BMT	1
	T5035PS	35mm Steel Top Hat Perforated 2.9m	Galvanised Top Hat used as cladding substrate. Grade: G2 Steel Coating: Z 275 Thickness: 1.15BMT	1
	T5035PL	35mm Steel Top Hat Perforated 5.8m	Galvanised Top Hat used as cladding substrate. Grade: G2 Steel Coating: Z 275 Thickness: 1.15BMT	1

OTHER INSTALLATION ACCESSORIES



	NAME	DESCRIPTION	UNIT QUANTITY
	Gasket Tape	EPDM closed cell foam gasket tape with single sided self-adhesive. For use on vertical top hats.	48 x 3mm x 25m Roll 25 x 3mm x 25m Roll
	Drill Bit	For use when pre-drilling Genesis boards.	9 x 35/70mm
	Centering Drill Bit	Used for pre-drilling top hats.	9G/4.9mm
	Stainless Steel Rivet	Used to face fix Genesis boards. The entire range of rivets come with washers attached and are colour coded to match the board. The fixed-point sleeves are sold separately in a box of 100.	4.8 x 20mm SS Rivet w/washer Sleeve for SS Rivet
	Stand-off Nosepiece	Special nosepiece that must be used for Genesis Signature Facade Rivets.	1
	250mL Edge Sealer Kit	For use with Genesis boards to seal edges after cutting.	1
	Saw Blade	Saw blade designed for fast and clean cutting of Genesis facade boards using a plunge or circular saw. 160mm Dia x 4T x 20mm	1

MEMBRANES

	CODE	NAME	DESCRIPTION	UNIT QUANTITY
	VWS50	Vitrafix Wall Sarking 1500mm x 50m Roll	Vitrafix Wall Sarking is a Class 4 vapour permeable membrane and an effective water barrier. With a 12-year warranty, it can withstand direct UV exposure for up to 3 months.	1 Roll
	VWSU30	Vitrafix Wall Sarking Ultra 1500mm x 30m Roll	Vitrafix Wall Sarking Ultra is a Class 4, heavy duty vapour permeable membrane and an effective water barrier. With a 15-year warranty, it can withstand direct UV exposure for up to 6 months and has superior strength characteristics for high wind zones.	1 Roll
	MSE150	Pro Clima Solitex Extasana Wall Membrane - 150	Pro Clima Solitex Extasana Wall Membrane is a high performance, monolithic nonporous membrane. Can be exposed to the elements for 90 days. 55m ² per roll.	1
	VWST25	Vitrafix Sarking Tape 60mm x 25m Roll	Vitrafix Sarking Tape is used for sealing overlapping joints and areas where water ingress may occur.	1 Roll
	VWSTD100	Vitrafix Double Sided Sarking Tape 60mm x 100m	Vitrafix Double Sided Sarking Tape is used to temporarily fix sarking to framing prior to installation of the facade.	1 Roll
	MTE60	Pro Clima Weathertight Sealing Tape – Tescon Extora 60mm	Weathertight Sealing Tape used to seal Pro Clima membrane. Easy to cut, thin and flexible, can be applied to cold and wet surfaces, highly UV stabilised.	10
	MTEP60	Pro Clima Corner Tape – Tescon Extora Profil 60mm	Split release paper for corner of window/door installations. Thin and flexible, can be applied to cold and wet surfaces, highly UV stabilised.	5
	MTES150	Pro Clima Sill Tape – Tescon Extoseal 150mm	Pro Clima Sill Tape - Tescon Extoseal is a one-piece stretchable sill tape, no need for corner moulds, can be applied to damp surfaces, very high adhesion on cold surfaces, no heating necessary, highly UV stabilised.	2
	VWSEPDMS	Vitrafix EPDM Sleeve – Custom	EPDM Sleeve is used to weatherproof areas where a fixture, such as a pipe etc, penetrates the sarking material. Custom sizes are available, contact the Fairview team with specific size requirements.	Please contact the Fairview team for more details

*The use of these accessories needs to be checked for compliance on your project

INSULATION

	CODE	PRODUCT	R-VALUE [M ² K/W] ROUNDED TO 0.05	THICKNESS [MM]	DENSITY [KG/ M ³]	PACK M ²	PACKS/ PALLET
	RSS3502512	ROCKWOOL™ Safe'n'Silent Pro350 1200 x 600 x 25mm 12/PAC	0.70	25	60	8.64	12
	RSS350506	ROCKWOOL™ Safe'n'Silent Pro350 1200 x 600 x 50mm 6/PAC	1.45	50	60	4.32	12
	RSS350754	ROCKWOOL™ Safe'n'Silent Pro350 1200 x 600 x 75mm 4/PAC	2.15	75	60	2.88	12
	RSS3501003	ROCKWOOL™ Safe'n'Silent Pro350 1200 x 600 x 100mm 3/PAC	2.85	100	60	2.16	12
	RRS9502512	ROCKWOOL™ Rainscreen SL950 1200 x 600 x 25mm 12/PAC	0.70	25	80	8.64	12
	RRS950388	ROCKWOOL™ Rainscreen SL950 1200 x 600 x 38mm 8/PAC	1.10	38	80	5.76	12
	RRS950506	ROCKWOOL™ Rainscreen SL950 1200 x 600 x 50mm 6/PAC	1.45	50	80	4.32	12
	RRS950754	ROCKWOOL™ Rainscreen SL950 1200 x 600 x 75mm 4/PAC	2.15	75	80	2.88	12
	RRS9501003	ROCKWOOL™ Rainscreen SL950 1200 x 600 x 100mm 3/PAC	2.85	100	80	2.16	12

OTHER SIZES/THICKNESSES ARE AVAILABLE ON REQUEST. PLEASE CONTACT THE FAIRVIEW TEAM FOR MORE INFORMATION

VITRADUAL SOLID ALUMINIUM FACADE SYSTEM

Vitradual is a 3mm solid aluminium facade system that forms part of Fairview's range of NCC compliant, deemed non-combustible cladding solutions. Vitradual is a high impact resistant, solid panel which can be fabricated, curved and rolled.

Vitradual is offered as a fully integrated cladding system that has been rigorously tested and is CodeMark Certified as a tested system. Fairview offers a comprehensive range of sub-framing components designed to seamlessly integrate with the Vitradual cladding system, ensuring full compliance with building codes and the rigorous testing that Vitradual has undergone. These sub-framing components are engineered to support the structural integrity of the cladding while providing a reliable foundation that enhances the overall performance of the system.

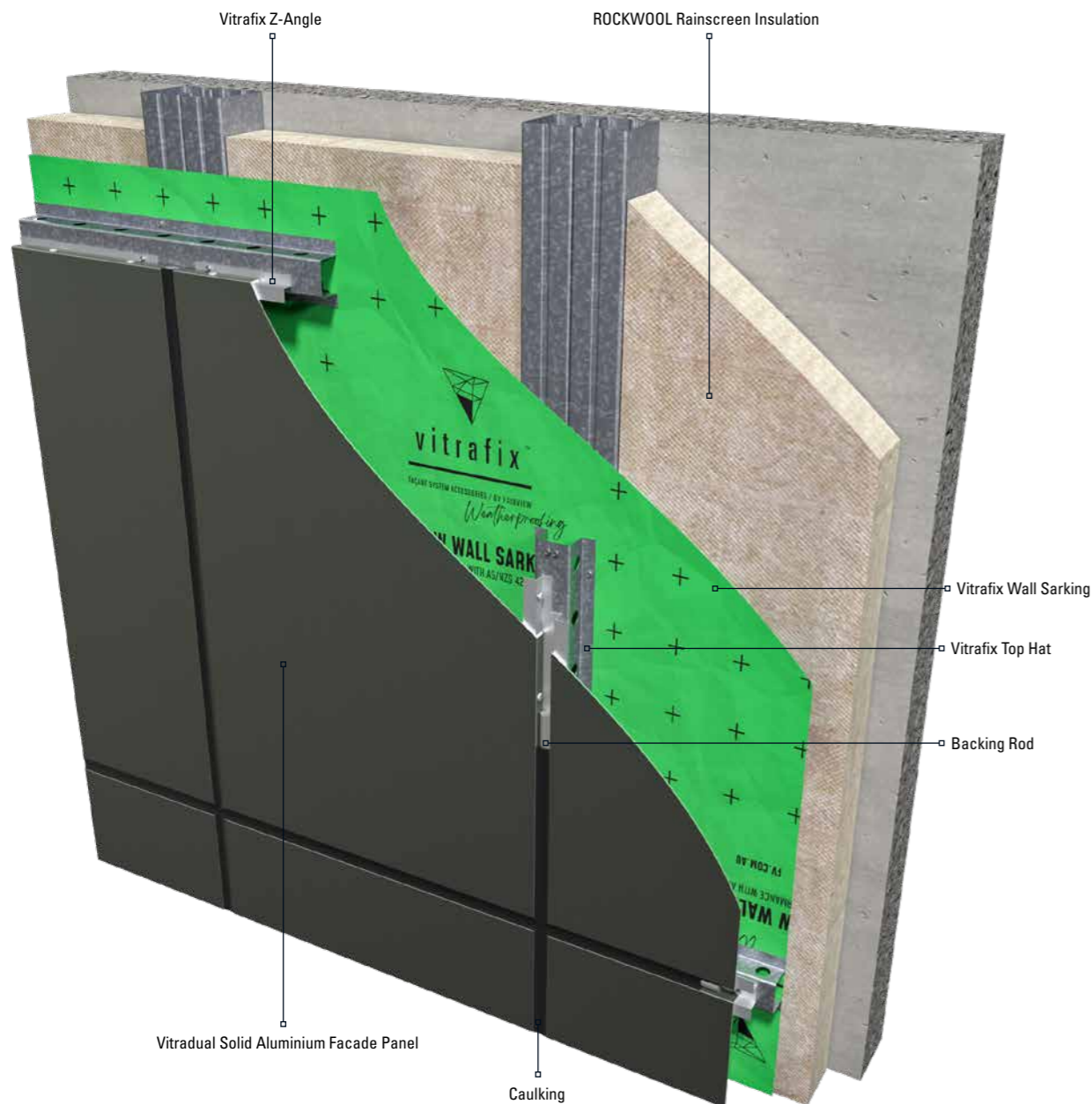

NON-COMBUSTIBLE CASSETTE CLADDING / MANUFACTURED BY FAIRVIEW

VITRADUAL TESTING AND COMPLIANCE

Fairview's Vitradual solid aluminium cassette cladding system has been intensively tested to ensure durability, strength and compliance to the Building Code of Australia. The following testing and compliance assessments have been completed for Vitradual:

TEST STANDARD	RESULT		
AS 1530.1	Non-Combustible		
AS 1530.3	Pass	Ignitability Index	0
	Pass	Heat Evolved	0
	Pass	Spread of Flame	0
	Pass	Smoke Developed	1

1. COATING DURABILITY

AAMA2605 test is conducted to evaluate the durability and performance of architectural coatings, particularly on aluminium and metal products exposed to outdoor environments.

This test simulates long-term exposure to harsh conditions such as UV radiation, temperature fluctuations, humidity and pollutants, ensuring the coating maintains its aesthetic appearance and protective properties over time. AAMA2605 testing is fundamental to demonstrating long term resistance to fading, chalking and corrosion.

Fairview's Vitradual has undergone testing to AAMA2605, ensuring a durable facade with long term visual appeal and structural integrity.



TEST ITEMS, METHODS AND RESULTS

AAMA2605-17 Voluntary Specification, Performance Requirements and Test Procedures for Superior Performing Organic Coatings on Aluminium Extrusions and Panels.

CLASSIFICATION	TEST STANDARD	RESULT	COMMENTS
Colour Uniformity	ASTM D2244-16	$\Delta E = 0.06$	Pass
Specular Gloss	ASTM D523-14	G 24.8	Pass
Dry Film Hardness	ASTM D3363-05 (R2011)e2	3H	Pass
Film Adhesion	ASTM D3359-17	Dry: 5B Wet: 5B Boiling Water: 5B	Pass
Impact Resistance	AAMA 2605 (8.5)	After impact, no removal	Pass
Abrasion Resistance	ASTM D968-17A	118.6	Pass
Muriatic Acid Resistance (15min spot)	AAMA 2605 (8.7.1)	5B	Pass
Mortar Resistance (24hr pat test)	AAMA 2605 (8.7.2)	5B	Pass
Nitric Acid Resistance	AAMA 2605 (8.7.3)	$\Delta E = 0.31$	Pass
Detergent Resistance	AAMA 2605 (8.7.4)	5B	Pass
Window Cleaner Resistance	AAMA 2605 (8.7.5)	5B	Pass

Please contact the Fairview team for a copy of the full report.

2. WALL SARKING

Vitradual solid aluminium facade system is offered with the Fairview Vitrafix range of weatherproof membranes. Vitrafix Wall Sarking, Vitrafix Wall Sarking Ultra and Pro Clima Solitex Extasana have been tested to ensure compliance to the Building Code of Australia requirements.

BREATHABLE MEMBRANES DATA

		PROCLIMA SOLITEX EXTASANA	FAIRVIEW WALL SARKING VWS50	FAIRVIEW WALL SARKING ULTRA [REINFORCED] VWSU30
AS/NZS 4201.1-1994	Resistance to Dry Delamination	N/A	Pass	Pass
AS/NZS 4201.2-1994	Resistance to Wet Delamination	N/A	Pass	Pass
AS/NZS 4201.3-1994	Shrinkage	0.00%	0.002	0.002
AS1301.448s-2019	Tensile Strength - Mean (MD)	4.8 kN/m	4.3 kN/m	7.9 kN/m
	Tensile Strength - Mean (LD)	3.7 kN/m	2.7 kN/m	8.7 kN/m
ASNZS 4200.1-2017 Clause 5.3.2.3	Edge Tear Resistance - Mean (MD)	251N	210N	419 N
	Edge Tear Resistance - Mean (LD)	188N	140N	388 N
AS2001.2.19-1988	Bursting Force - Mean	>200N	258N	522N
AS/NZS 4201.5.1994	Emittance	NN	Non-Reflective	Non-Reflective
ASTM E96-2016	Water Vapour Transmission	Class 4	Class 4	Class 4
AS/NZS 4201.4-1994	Resistance to Water Penetration	Water Barrier (Pass)	Water Barrier (Pass)	Water Barrier (Pass)
AS/NZS 3100-2017	Surface Resistivity	Electrically Non-Cond.	Electrically Non-Cond.	Electrically Non-Cond.
AS 1530.2-1993	Flammability Index	<5	1 (Low)	4 (Low)
Thickness	Nominal Thickness	0.60mm	0.50mm	0.70mm
UV Resistance	Prior to being overlaid	180 Days	3 months	6 months
Warranty		10 years	12 years	15 years

3. ROCKWOOL INSULATION

ROCKWOOL Rainscreen is a stone wool insulation developed specifically for use within ventilated cladding systems. Fairview has selected a range of Rockwool insulation products to suit most building applications. This includes:

ROCKWOOL RAINSCREEN SL950/SL960 PRODUCT SPECIFICATION

R-VALUE M2K/W	THICKNESS [MM]	WIDTH [MM]	LENGTH [MM]	# PIECES PER PACK	AREA PER PACK [M2]
0.75	25	600	1200	12	4.32
1.45	50	600	1200	6	4.32
2.20	75	600	1200	4	2.16
2.95	100	600	1200	3	2.16



4. SUB-FRAMING FOR TESTING COMPLIANCE

In order to ensure compliance and durability, the coil used to produce all Fairview Vitrafix Top Hats is tested in a NATA accredited test lab before being rolled into top hats.

This testing confirms compliance to AS1397.

SAMPLE NO.	METALLIC COATING DESIGNATION	MEASURED SINGLE SPOT TOTAL COATING MASS BOTH SIDES [G/M ²]	AS 1397 TABLE 3.1 MIN. COATING MASS REQUIREMENT [G/M ²]	MEASURED BASE METAL THICKNESS [MM]	AS/NZS 1365 TABLE 5.1 THICKNESS TOLERANCES [MM]
1	Z275	310	250	1.14	1.15 ± 0.05
2	Z275	310	250	1.15	1.15 ± 0.05
3	Z275	265	250	1.14	1.15 ± 0.05
4	Z275	265	250	1.14	1.15 ± 0.05
5	Z275	255	250	1.14	1.15 ± 0.05
6	Z275	270	250	1.14	1.15 ± 0.05

Note: Coating mass rounded to 5 g/m², as per AS 1397:2021



Vitrafix 35mm Galvanised Steel Perforated Top Hat

Report No: 23-1094-A
Report Date: 30 October 2023

Head Office Address:
Unit 1, 15 Pickering Road
Mulgrave VIC 3170

Ph: 03 9560 2759
e: info@melbtest.com.au

TENSILE TEST REPORT

In confidence to the client:

Fairview
18 - 20 Donald Street
Lithgow NSW 2790

Date of Testing: 26 October 2023
Specimen Description: Galvanised Steel Coil Samples
Testing Machine: Insight 300kN MT-3003 Grade A
Strain Device: Epsilon 50mm Extensometer MT-1238 0.001mm

	1	2	3	4	5	6
SPECIMEN DETAILS:						
Specimen I.D:	HR2301 507201	HR2301 507202	HR2301 507203	HR2301 507301	HR2301 507302	HR2301 507303
Thickness:	a (mm) 1.14	1.15	1.14	1.14	1.14	1.14
Width:	b (mm) 12.27	12.27	12.32	12.34	12.32	12.35
Area:	S _o (mm ²) 13.99	14.11	14.04	14.07	14.04	14.08
Gauge Length:	L _o (mm) 50	50	50	50	50	50
Parallel Length:	L _c (mm) 75	75	75	75	75	75
TENSILE PROPERTIES:						
Tensile Strength:	R _m (MPa) 400	390	360	400	390	400
Lower Yield Stress:	R _{0.2} (MPa) 330	310	305	325	305	320
Post Fracture Elongation:	A _{50mm} (%) 32	28	30	30	28	36
TEST COMMENTS:	Tested and reported as a reduced-section samples in accordance with AS 1391-2020 and AS 1397-2021.					
Area (S _o) computed on base metal thickness (BMT).						
Tensile Strength (R _m) and Lower Yield Stress (R _{0.2}) results have been rounded to the nearest 10MPa and 5MPa, respectively.						
Tensile properties of the tested sample are deemed to comply with AS 1397 Table 2.3; Steel Grade Designation G300.						

Authorised Signatory:
Dan Humphrey

COMMITMENT TO QUALITY, THE ENVIRONMENT AND COMPLIANCE

The Vitradual solid aluminium cladding range has been engineered for quality, durability, environmental stewardship and compliance to local building requirements. This is evidenced by the industry-leading warranties, independent compliance certification and environmental credentials held by Vitradual, making it the right choice for Australian designs.



VITRADUAL SOLID ALUMINIUM SYSTEM COMPONENT LIST





SUB-FRAMING ACCESSORIES

CODE	NAME	DESCRIPTION	UNIT QUANTITY								
S2535PS	Vitradual Cladding Panel	Prefinished 3mm solid aluminium available in standard and custom panel sizes. <table border="1" style="margin-left: 20px;"> <thead> <tr> <th>Width</th> <th>Length</th> </tr> </thead> <tbody> <tr> <td>1250/1500</td> <td>200</td> </tr> <tr> <td></td> <td>3200</td> </tr> <tr> <td></td> <td>4000</td> </tr> </tbody> </table>	Width	Length	1250/1500	200		3200		4000	LM
Width	Length										
1250/1500	200										
	3200										
	4000										
T5015S	15mm Steel Top Hat 2.9m	Galvanised Top Hat used as cladding substrate. Grade: G2 Steel Coating: Z 275 Thickness: 1.15BMT	1								
T5015L	15mm Steel Top Hat 5.8m	Galvanised Top Hat used as cladding substrate. Grade: G2 Steel Coating: Z 275 Thickness: 1.15BMT	1								
T5024S	24mm Steel Top Hat 2.9m	Galvanised Top Hat used as cladding substrate. Grade: G2 Steel Coating: Z 275 Thickness: 1.15BMT	1								
T5024L	24mm Steel Top Hat 5.8m	Galvanised Top Hat used as cladding substrate. Grade: G2 Steel Coating: Z 275 Thickness: 1.15BMT	1								

SUB-FRAMING ACCESSORIES

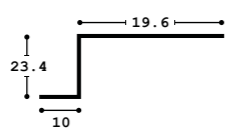
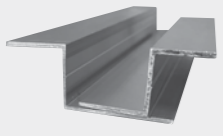
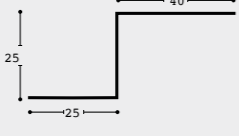
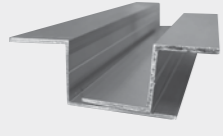
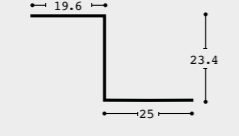
CODE	NAME	DESCRIPTION	UNIT QUANTITY
T5024PS	24mm Steel Top Hat Perforated 2.9m	Galvanised Top Hat used as cladding substrate. Grade: G2 Steel Coating: Z 275 Thickness: 1.15BMT	1
T5024PL	24mm Steel Top Hat Perforated 5.8m	Galvanised Top Hat used as cladding substrate. Grade: G2 Steel Coating: Z 275 Thickness: 1.15BMT	1
T5035S	35mm Steel Top Hat 2.9m	Galvanised Top Hat used as cladding substrate. Grade: G2 Steel Coating: Z 275 Thickness: 1.15BMT	1
T5035L	35mm Steel Top Hat 5.8m	Galvanised Top Hat used as cladding substrate. Grade: G2 Steel Coating: Z 275 Thickness: 1.15BMT	1
T5035PS	35mm Steel Top Hat Perforated 2.9m	Galvanised Top Hat used as cladding substrate. Grade: G2 Steel Coating: Z 275 Thickness: 1.15BMT	1
T5035PL	35mm Steel Top Hat Perforated 5.8m	Galvanised Top Hat used as cladding substrate. Grade: G2 Steel Coating: Z 275 Thickness: 1.15BMT	1
AZ4025L	Aluminium High Z Angle – 5.8m	Used in the construction of cassette, mechanical fix installation method. Grade: 6060/6063 Temper: T5 Thickness: 1.6mm For use with: Vitracore G2, Vitradual	1

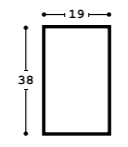
SUB-FRAMING ACCESSORIES





	CODE	NAME	DESCRIPTION	UNIT QUANTITY
	AZ2310L	Aluminium Low Z Angle – 5.8m 	Used in the construction of cassette, mechanical fix installation method. Grade: 6060/6063 Temper: T5 Thickness: 1.6mm For use with: Vitracore G2, Vitradual	1
	AZ2540	Long Leg Aluminium Z Angle High - 6m 	Used in the construction of cassette, mechanical fix installation method. NEW - Extended 25mm foot to allow for tape or construction adhesive to be applied to strengthen the cassette fold. Grade: 6060/6063 Temper: T5 Thickness: 1.6mm	1
	AZ2325	Long Leg Aluminium Z Angle Low - 6m 	Used in the construction of cassette, mechanical fix installation method. NEW - Extended 25mm foot to allow for tape or construction adhesive to be applied to strengthen the cassette fold. Grade: 6060/6063 Temper: T5 Thickness: 1.6mm	1
	AR3819L	Aluminium Stiffener – 5.8m 	Used to stiffen aluminium panels - attached to the rear of panel Grade: 6060/6063 Temper: T5 Thickness: 1.6mm	1
	AL3203	Aluminium Angle – 6m 	Corner reinforcement for cassette system. Grade: 6060/6063 Temper: T5 Thickness: 3mm	2

MEMBRANES

	CODE	NAME	DESCRIPTION	UNIT QUANTITY
	VWS50	Vitrafix Wall Sarking 1500mm x 50m Roll	Vitrafix Wall Sarking is a Class 4 vapour permeable membrane and an effective water barrier. With a 12-year warranty, it can withstand direct UV exposure for up to 3 months.	1 Roll
	VWSU30	Vitrafix Wall Sarking Ultra 1500mm x 30m Roll	Vitrafix Wall Sarking Ultra is a Class 4, heavy duty vapour permeable membrane and an effective water barrier. With a 15-year warranty, it can withstand direct UV exposure for up to 6 months and has superior strength characteristics for high wind zones.	1 Roll
	MSE150	Pro Clima Solitex Extasana Wall Membrane - 150	Pro Clima Solitex Extasana Wall Membrane is a high performance, monolithic nonporous membrane. Can be exposed to the elements for 90 days. 55m ² per roll.	1
	VWST25	Vitrafix Sarking Tape 60mm x 25m Roll	Vitrafix Sarking Tape is used for sealing overlapping joints and areas where water ingress may occur.	1 Roll
	VWSTD100	Vitrafix Double Sided Sarking Tape 60mm x 100m	Vitrafix Double Sided Sarking Tape is used to temporarily fix sarking to framing prior to installation of the facade.	1 Roll
	MTE60	Pro Clima Weathertight Sealing Tape – Tescon Extora 60mm	Weathertight Sealing Tape used to seal Pro Clima membrane. Easy to cut, thin and flexible, can be applied to cold and wet surfaces, highly UV stabilised.	10
	MTEP60	Pro Clima Corner Tape – Tescon Extora Profil 60mm	Split release paper for corner of window/door installations. Thin and flexible, can be applied to cold and wet surfaces, highly UV stabilised.	5
	MTES150	Pro Clima Sill Tape – Tescon Extoseal 150mm	Pro Clima Sill Tape - Tescon Extoseal is a one-piece stretchable sill tape, no need for corner moulds, can be applied to damp surfaces, very high adhesion on cold surfaces, no heating necessary, highly UV stabilised.	2
	VWSEPDMS	Vitrafix EPDM Sleeve – Custom	EPDM Sleeve is used to weatherproof areas where a fixture, such as a pipe etc, penetrates the sarking material. Custom sizes are available, contact the Fairview team with specific size requirements.	Please contact the Fairview team for more details

*The use of these accessories needs to be checked for compliance on your project

CAULKING

	CODE	NAME	DESCRIPTION	UNIT QUANTITY
	CAM41B	Admil Prosil 41LM – Black – 600mL Sausage	Low modulus, high movement, matt finish silicone, designed for weather sealing cladding expansion joints. 600ML sausage	20
	CAM41W	Admil Prosil 41LM – White - 600mL Sausage	Low modulus, high movement, matt finish silicone, designed for weather sealing cladding expansion joints. 600ML sausage	20
	CAM41G	Admil Prosil 41LM – Grey - 600mL Sausage	Low modulus, high movement, matt finish silicone, designed for weather sealing cladding expansion joints. 600ML sausage	20
	CBR016	Open Cell Backing Rod – 16mm x 150m	Joint filler and sealant backer for cassette installation method.	1 Roll or 20 Rolls



*The use of these accessories needs to be checked for compliance on your project

FIXINGS

	CODE	NAME	DESCRIPTION	UNIT QUANTITY
	FW1016	Self Drilling Wafer Tek Phillips 10-16 x 16mm	For fixing Z Angles to Top Hats and attaching Top Hats to framing. Class 3 Galvanised. Box 1000 Pcs.	Box of 1000
	FR48	4.8mm x 11.4mm Pop Rivets	For fixing Z Angles to aluminium facade panels. Box 1000 Pcs.	Box of 1000

*The use of these accessories needs to be checked for compliance on your project

INSULATION

	CODE	PRODUCT	R-VALUE (M2K/W) ROUNDED TO 0.05	THICKNESS (MM)	DENSITY (KG/ M3)	PACK M2	PACKS/ PALLET
	RSS3502512	ROCKWOOL™ Safe'n'Silent Pro350 1200 x 600 x 25mm 12/PAC	0.70	25	60	8.64	12
	RSS350506	ROCKWOOL™ Safe'n'Silent Pro350 1200 x 600 x 50mm 6/PAC	1.45	50	60	4.32	12
	RSS350754	ROCKWOOL™ Safe'n'Silent Pro350 1200 x 600 x 75mm 4/PAC	2.15	75	60	2.88	12
	RSS3501003	ROCKWOOL™ Safe'n'Silent Pro350 1200 x 600 x 100mm 3/PAC	2.85	100	60	2.16	12
	RRS9502512	ROCKWOOL™ Rainscreen SL950 1200 x 600 x 25mm 12/PAC	0.70	25	80	8.64	12
	RRS950388	ROCKWOOL™ Rainscreen SL950 1200 x 600 x 38mm 8/PAC	1.10	38	80	5.76	12
	RRS950506	ROCKWOOL™ Rainscreen SL950 1200 x 600 x 50mm 6/PAC	1.45	50	80	4.32	12
	RRS950754	ROCKWOOL™ Rainscreen SL950 1200 x 600 x 75mm 4/PAC	2.15	75	80	2.88	12
	RRS9501003	ROCKWOOL™ Rainscreen SL950 1200 x 600 x 100mm 3/PAC	2.85	100	80	2.16	12

OTHER SIZES/THICKNESSES ARE AVAILABLE ON REQUEST. PLEASE CONTACT THE FAIRVIEW TEAM FOR MORE INFORMATION

VITRACORE G2 ENGINEERED ALUMINIUM FACADE SYSTEM

Vitracore G2 is an engineered aluminium panel designed for high performance as a facade material, that is half the weight, 5x more rigid and has 70% greater resistance to oil canning than its solid panel counterparts.

Vitracore G2 is offered as a fully integrated cladding system that has been rigorously tested and is CodeMark certified as a tested system. Fairview offers a comprehensive range of sub-framing components designed to seamlessly integrate with the Vitracore G2 cladding system, ensuring full compliance with building codes and the rigorous testing that Vitracore G2 has undergone. These sub-framing components are engineered to support the structural integrity of the cladding while providing a reliable foundation that enhances the overall performance of the system.

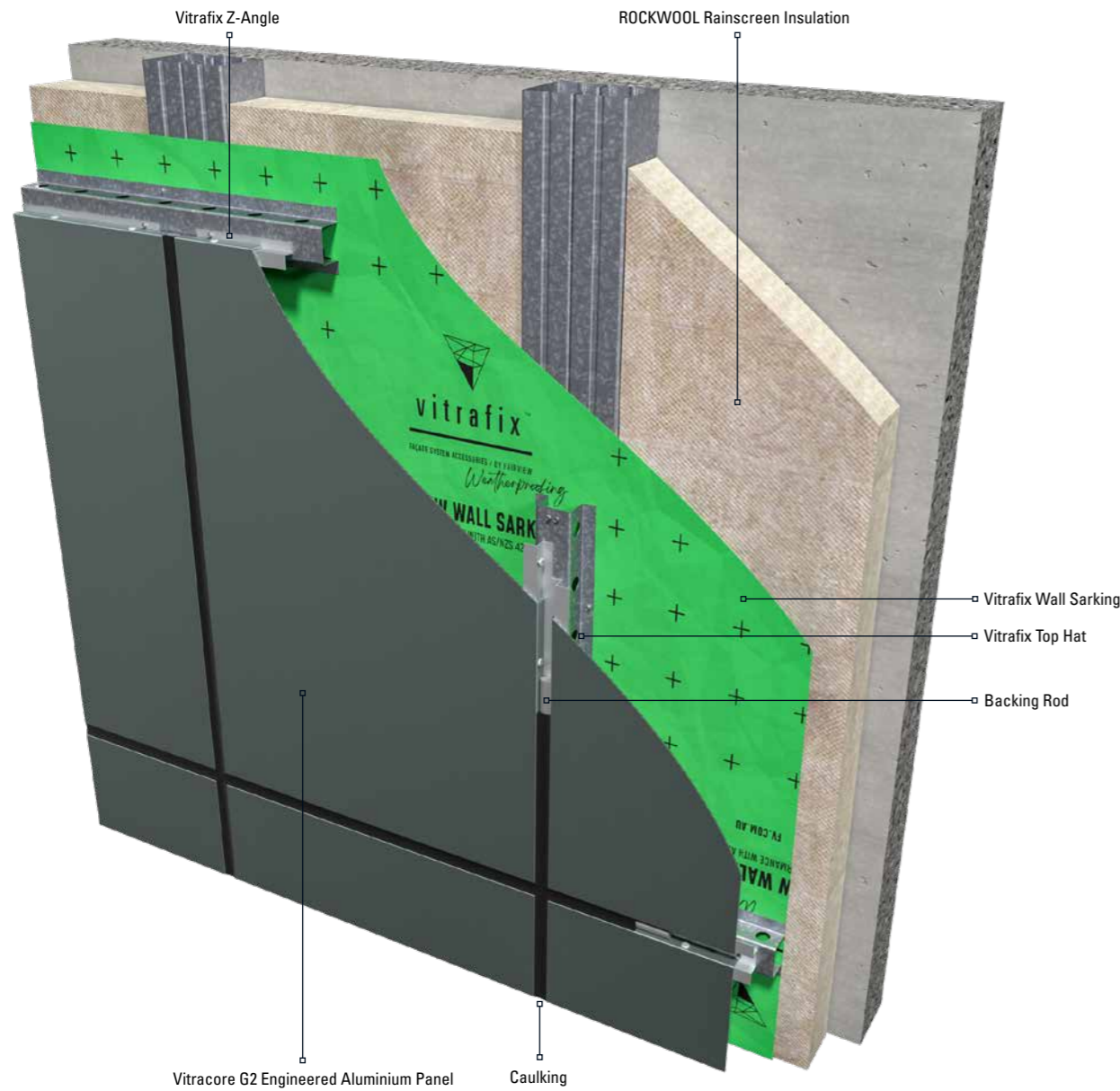

VITRACORE G2 TESTING AND COMPLIANCE

Fairview's Vitracore G2 engineered aluminium cladding system has been intensively tested to ensure durability, strength and compliance to the Building Code of Australia. The following testing and compliance assessments have been completed for Vitracore G2:

TEST STANDARD	RESULT		
AS 1530.1	Non-Combustible		
	Pass	Ignitability Index	0
AS 1530.3	Pass	Heat Evolved	0
	Pass	Spread of Flame	0
	Pass	Smoke Developed	1

1. COATING DURABILITY

AAMA2605 test is conducted to evaluate the durability and performance of architectural coatings, particularly on aluminium and metal products exposed to outdoor environments.

This test simulates long-term exposure to harsh conditions such as UV radiation, temperature fluctuations, humidity and pollutants, ensuring the coating maintains its aesthetic appearance and protective properties over time. AAMA2605 testing is fundamental to demonstrating long term resistance to fading, chalking and corrosion.

Fairview's Vitracore G2 has undergone testing to AAMA2605, ensuring a durable facade with long term visual appeal and structural integrity.



TEST ITEMS, METHODS AND RESULTS

AAMA2605-17 Voluntary Specification, Performance Requirements and Test Procedures for Superior Performing Organic Coatings on Aluminium Extrusions and Panels.

CLASSIFICATION	TEST STANDARD	RESULT	COMMENTS
Colour Uniformity	ASTM D2244-16	$\Delta E = 0.03$	Pass
Specular Gloss	ASTM D523-14	G 34.4	Pass
Dry Film Hardness	ASTM D3363-05 (R2011)e2	2H	Pass
Film Adhesion	ASTM D3359-17	Dry: 5B Wet: 5B Boiling Water: 5B	Pass
Impact Resistance	AAMA 2605 (8.5)	There was a crack at the perimeter of the concave area, but no coating pick off	Pass
Abrasion Resistance	ASTM D968-17A	146	Pass
Muriatic Acid Resistance (15min spot)	AAMA 2605 (8.7.1)	5B	Pass
Mortar Resistance (24hr pat test)	AAMA 2605 (8.7.2)	5B	Pass
Nitric Acid Resistance	AAMA 2605 (8.7.3)	$\Delta E = 0.15$	Pass
Detergent Resistance	AAMA 2605 (8.7.4)	5B	Pass
Window Cleaner Resistance	AAMA 2605 (8.7.5)	5B	Pass

Please contact the Fairview team for a copy of the full report.

2. ENGINEERED FOR STRENGTH

Vitracore G2 is a bonded laminate panel that has been engineered to be lightweight, stronger and able to resist the effects of oil canning. Independent FEA analysis has shown that the Vitracore G2 offers 70% greater resistance to oil canning. Contact your Fairview representative for the FEA report.

3. WALL SARKING

Vitracore G2 aluminium facade system is offered with the Fairview Vitrafix range of weatherproof membranes. Vitrafix Wall Sarking, Vitrafix Wall Sarking Ultra and Pro Clima Solitex Extasana have been tested to ensure compliance to the Building Code of Australia requirements.

BREATHABLE MEMBRANES DATA

		PROCLIMA SOLITEX EXTASANA	FAIRVIEW WALL SARKING VWS50	FAIRVIEW WALL SARKING ULTRA [REINFORCED] VWSU30
AS/NZS 4201.1-1994	Resistance to Dry Delamination	N/A	Pass	Pass
AS/NZS 4201.2-1994	Resistance to Wet Delamination	N/A	Pass	Pass
AS/NZS 4201.3-1994	Shrinkage	0.00%	0.002	0.002
AS1301.448s-2019	Tensile Strength - Mean (MD)	4.8 kN/m	4.3 kN/m	7.9 kN/m
	Tensile Strength - Mean (LD)	3.7 kN/m	2.7 kN/m	8.7 kN/m
AS/NZS 4200.1-2017 Clause 5.3.2.3	Edge Tear Resistance - Mean (MD)	251N	210N	419 N
	Edge Tear Resistance - Mean (LD)	188N	140N	388 N
AS2001.2.19-1988	Bursting Force - Mean	>200N	258N	522N
AS/NZS 4201.5.1994	Emittance	NN	Non-Reflective	Non-Reflective
ASTM E96-2016	Water Vapour Transmission	Class 4	Class 4	Class 4
AS/NZS 4201.4-1994	Resistance to Water Penetration	Water Barrier (Pass)	Water Barrier (Pass)	Water Barrier (Pass)
AS/NZS 3100-2017	Surface Resistivity	Electrically Non-Cond.	Electrically Non-Cond.	Electrically Non-Cond.
AS 1530.2-1993	Flammability Index	<5	1 (Low)	4 (Low)
Thickness	Nominal Thickness	0.60mm	0.50mm	0.70mm
UV Resistance	Prior to being overclad	180 Days	3 months	6 months
Warranty		10 years	12 years	15 years

4. ROCKWOOL INSULATION

ROCKWOOL Rainscreen is a stone wool insulation developed specifically for use within ventilated cladding systems. Fairview has selected a range of Rockwool insulation products to suit most building applications. This includes:

ROCKWOOL RAINSCREEN SL950/SL960 PRODUCT SPECIFICATION

R-VALUE M2K/W	THICKNESS (MM)	WIDTH (MM)	LENGTH (MM)	# PIECES PER PACK	AREA PER PACK (M2)
0.75	25	600	1200	12	4.32
1.45	50	600	1200	6	4.32
2.20	75	600	1200	4	2.16
2.95	100	600	1200	3	2.16

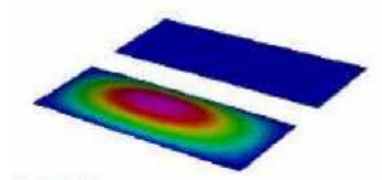

5. SUB-FRAMING TESTING FOR COMPLIANCE

In order to ensure compliance and durability, the coil used to produce all Fairview Vitrafix Top Hats is tested in a NATA accredited test lab before being rolled into top hats. This testing confirms compliance to AS1397.

SAMPLE NO.	METALLIC COATING DESIGNATION	MEASURED SINGLE SPOT TOTAL COATING MASS BOTH SIDES [G/M²]	AS 1397 TABLE 3.1 MIN. COATING MASS REQUIREMENT [G/M²]	MEASURED BASE METAL THICKNESS [MM]	AS/NZS 1365 TABLE 5.1 THICKNESS TOLERANCES [MM]
1	Z275	310	250	1.14	1.15 ± 0.05
2	Z275	310	250	1.15	1.15 ± 0.05
3	Z275	265	250	1.14	1.15 ± 0.05
4	Z275	265	250	1.14	1.15 ± 0.05
5	Z275	255	250	1.14	1.15 ± 0.05
6	Z275	270	250	1.14	1.15 ± 0.05

Note: Coating mass rounded to 5 g/m², as per AS 1397:2021



Vitrafix 35mm Galvanised Steel Perforated Top Hat

Report No: 23-1094-A
Report Date: 30 October 2023

Head Office Address:
Unit 1, 15 Pickering Road
Mulgrave VIC 3170

Ph: 03 9560 2759
e: info@melbtest.com.au

TENSILE TEST REPORT

In confidence to the client:

Fairview
18 - 20 Donald Street
Lithgow NSW 2790

Date of Testing: 26 October 2023
Specimen Description: Galvanised Steel Coil Samples
Testing Machine: Insight 300kN MT-3003 Grade A
Strain Device: Epsilon 50mm Extensometer MT-1238 0.001mm

	1	2	3	4	5	6
Specimen I.D:	HR2301 507201	HR2301 507202	HR2301 507203	HR2301 507301	HR2301 507302	HR2301 507303
Thickness:	1.14	1.15	1.14	1.14	1.14	1.14
Width:	12.27	12.27	12.32	12.34	12.32	12.35
Area:	13.99	14.11	14.04	14.07	14.04	14.08
Gauge Length:	50	50	50	50	50	50
Parallel Length:	75	75	75	75	75	75

TENSILE PROPERTIES:

Tensile Strength:	R_m (MPa)	400	390	360	400	390	400
Lower Yield Stress:	R_{d1} (MPa)	330	310	305	325	305	320
Post Fracture Elongation:	A_{50mm} (%)	32	28	30	30	28	36

TEST COMMENTS:
Tested and reported as a reduced-section samples in accordance with AS 1391-2020 and AS 1397-2021.

Area (S_n) computed on base metal thickness (BMT).

Tensile Strength (R_m) and Lower Yield Stress (R_{d1}) results have been rounded to the nearest 10MPa and 5MPa, respectively.

Tensile properties of the tested sample are deemed to comply with AS 1397 Table 2.3; Steel Grade Designation G300.

Authorised Signatory:
Dan Humfrey

COMMITMENT TO QUALITY, THE ENVIRONMENT AND COMPLIANCE

The Vitracore G2 aluminium cladding range has been engineered for quality, durability, environmental stewardship and compliance to local building requirements. This is evidenced by the industry-leading warranties, independent compliance certification and environmental credentials held by Vitracore G2, making it the right choice for Australian designs.



VITRACORE G2 ENGINEERED ALUMINIUM SYSTEM COMPONENT LIST





SUB-FRAMING ACCESSORIES

CODE	NAME	DESCRIPTION	UNIT QUANTITY				
S2535PS	Vitradual Cladding Panel	Engineered aluminium available in standard and custom panel sizes. <table border="1" style="margin-left: 20px;"> <thead> <tr> <th>Width</th> <th>Length</th> </tr> </thead> <tbody> <tr> <td>1250/1500</td> <td>3200 4000</td> </tr> </tbody> </table>	Width	Length	1250/1500	3200 4000	LM
Width	Length						
1250/1500	3200 4000						
T5015S	15mm Steel Top Hat 2.9m	Galvanised Top Hat used as cladding substrate. Grade: G2 Steel Coating: Z 275 Thickness: 1.15BMT	1				
T5015L	15mm Steel Top Hat 5.8m	Galvanised Top Hat used as cladding substrate. Grade: G2 Steel Coating: Z 275 Thickness: 1.15BMT	1				
T5024S	24mm Steel Top Hat 2.9m	Galvanised Top Hat used as cladding substrate. Grade: G2 Steel Coating: Z 275 Thickness: 1.15BMT	1				
T5024L	24mm Steel Top Hat 5.8m	Galvanised Top Hat used as cladding substrate. Grade: G2 Steel Coating: Z 275 Thickness: 1.15BMT	1				

SUB-FRAMING ACCESSORIES

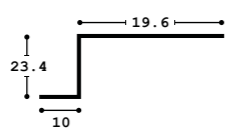
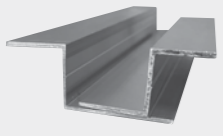
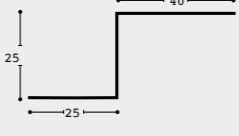
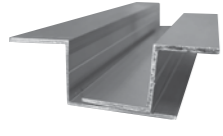
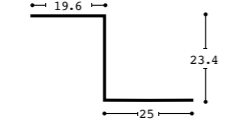
CODE	NAME	DESCRIPTION	UNIT QUANTITY
T5024PS	24mm Steel Top Hat Perforated 2.9m	Galvanised Top Hat used as cladding substrate. Grade: G2 Steel Coating: Z 275 Thickness: 1.15BMT	1
T5024PL	24mm Steel Top Hat Perforated 5.8m	Galvanised Top Hat used as cladding substrate. Grade: G2 Steel Coating: Z 275 Thickness: 1.15BMT	1
T5035S	35mm Steel Top Hat 2.9m	Galvanised Top Hat used as cladding substrate. Grade: G2 Steel Coating: Z 275 Thickness: 1.15BMT	1
T5035L	35mm Steel Top Hat 5.8m	Galvanised Top Hat used as cladding substrate. Grade: G2 Steel Coating: Z 275 Thickness: 1.15BMT	1
T5035PS	35mm Steel Top Hat Perforated 2.9m	Galvanised Top Hat used as cladding substrate. Grade: G2 Steel Coating: Z 275 Thickness: 1.15BMT	1
T5035PL	35mm Steel Top Hat Perforated 5.8m	Galvanised Top Hat used as cladding substrate. Grade: G2 Steel Coating: Z 275 Thickness: 1.15BMT	1
AZ4025L	Aluminium High Z Angle – 5.8m	Used in the construction of cassette, mechanical fix installation method. Grade: 6060/6063 Temper: T5 Thickness: 1.6mm For use with: Vitracore G2, Vitradual	1

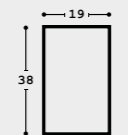
SUB-FRAMING ACCESSORIES

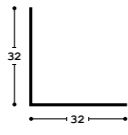



	CODE	NAME	DESCRIPTION	UNIT QUANTITY
	AZ2310L	Aluminium Low Z Angle – 5.8m 	Used in the construction of cassette, mechanical fix installation method. Grade: 6060/6063 Temper: T5 Thickness: 1.6mm For use with: Vitracore G2, Vitradual	1
	AZ2540	Long Leg Aluminium Z Angle High - 6m 	Used in the construction of cassette, mechanical fix installation method. NEW - Extended 25mm foot to allow for tape or construction adhesive to be applied to strengthen the cassette fold. Grade: 6060/6063 Temper: T5 Thickness: 1.6mm	1
	AZ2325	Long Leg Aluminium Z Angle Low - 6m 	Used in the construction of cassette, mechanical fix installation method. NEW - Extended 25mm foot to allow for tape or construction adhesive to be applied to strengthen the cassette fold. Grade: 6060/6063 Temper: T5 Thickness: 1.6mm	1
	AR3819L	Aluminium Stiffener – 5.8m 	Used to stiffen aluminium panels - attached to the rear of panel Grade: 6060/6063 Temper: T5 Thickness: 1.6mm	1
	AL3203	Aluminium Angle – 6m 	Corner reinforcement for cassette system. Grade: 6060/6063 Temper: T5 Thickness: 3mm	2

MEMBRANES

	CODE	NAME	DESCRIPTION	UNIT QUANTITY
	VWS50	Vitrafix Wall Sarking 1500mm x 50m Roll	Vitrafix Wall Sarking is a Class 4 vapour permeable membrane and an effective water barrier. With a 12-year warranty, it can withstand direct UV exposure for up to 3 months.	1 Roll
	VWSU30	Vitrafix Wall Sarking Ultra 1500mm x 30m Roll	Vitrafix Wall Sarking Ultra is a Class 4, heavy duty vapour permeable membrane and an effective water barrier. With a 15-year warranty, it can withstand direct UV exposure for up to 6 months and has superior strength characteristics for high wind zones.	1 Roll
	MSE150	Pro Clima Solitex Extasana Wall Membrane - 150	Pro Clima Solitex Extasana Wall Membrane is a high performance, monolithic nonporous membrane. Can be exposed to the elements for 90 days. 55m ² per roll.	1
	VWST25	Vitrafix Sarking Tape 60mm x 25m Roll	Vitrafix Sarking Tape is used for sealing overlapping joints and areas where water ingress may occur.	1 Roll
	VWSTD100	Vitrafix Double Sided Sarking Tape 60mm x 100m	Vitrafix Double Sided Sarking Tape is used to temporarily fix sarking to framing prior to installation of the facade.	1 Roll
	MTE60	Pro Clima Weathertight Sealing Tape – Tescon Extora 60mm	Weathertight Sealing Tape used to seal Pro Clima membrane. Easy to cut, thin and flexible, can be applied to cold and wet surfaces, highly UV stabilised.	10
	MTEP60	Pro Clima Corner Tape – Tescon Extora Profil 60mm	Split release paper for corner of window/door installations. Thin and flexible, can be applied to cold and wet surfaces, highly UV stabilised.	5
	MTES150	Pro Clima Sill Tape – Tescon Extoseal 150mm	Pro Clima Sill Tape - Tescon Extoseal is a one-piece stretchable sill tape, no need for corner moulds, can be applied to damp surfaces, very high adhesion on cold surfaces, no heating necessary, highly UV stabilised.	2
	VWSEPDMS	Vitrafix EPDM Sleeve – Custom	EPDM Sleeve is used to weatherproof areas where a fixture, such as a pipe etc, penetrates the sarking material. Custom sizes are available, contact the Fairview team with specific size requirements.	Please contact the Fairview team for more details

*The use of these accessories needs to be checked for compliance on your project

CAULKING

	CODE	NAME	DESCRIPTION	UNIT QUANTITY
	CAM41B	Admil Prosil 41LM – Black – 600mL Sausage	Low modulus, high movement, matt finish silicone, designed for weather sealing cladding expansion joints. 600ML sausage	20
	CAM41W	Admil Prosil 41LM – White - 600mL Sausage	Low modulus, high movement, matt finish silicone, designed for weather sealing cladding expansion joints. 600ML sausage	20
	CAM41G	Admil Prosil 41LM – Grey - 600mL Sausage	Low modulus, high movement, matt finish silicone, designed for weather sealing cladding expansion joints. 600ML sausage	20
	CBR016	Open Cell Backing Rod – 16mm x 150m	Joint filler and sealant backer for cassette installation method.	1 Roll or 20 Rolls



*The use of these accessories needs to be checked for compliance on your project

FIXINGS

	CODE	NAME	DESCRIPTION	UNIT QUANTITY
	FW1016	Self Drilling Wafer Tek Phillips 10-16 x 16mm	For fixing Z Angles to Top Hats and attaching Top Hats to framing. Class 3 Galvanised. Box 1000 Pcs.	Box of 1000
	FR48	4.8mm x 11.4mm Pop Rivets	For fixing Z Angles to aluminium facade panels. Box 1000 Pcs.	Box of 1000

*The use of these accessories needs to be checked for compliance on your project

INSULATION

	CODE	PRODUCT	R-VALUE (M2K/W) ROUNDED TO 0.05	THICKNESS (MM)	DENSITY (KG/ M3)	PACK M2	PACKS/ PALLET
	RSS3502512	ROCKWOOL™ Safe'n'Silent Pro350 1200 x 600 x 25mm 12/PAC	0.70	25	60	8.64	12
	RSS350506	ROCKWOOL™ Safe'n'Silent Pro350 1200 x 600 x 50mm 6/PAC	1.45	50	60	4.32	12
	RSS350754	ROCKWOOL™ Safe'n'Silent Pro350 1200 x 600 x 75mm 4/PAC	2.15	75	60	2.88	12
	RSS3501003	ROCKWOOL™ Safe'n'Silent Pro350 1200 x 600 x 100mm 3/PAC	2.85	100	60	2.16	12
	RRS9502512	ROCKWOOL™ Rainscreen SL950 1200 x 600 x 25mm 12/PAC	0.70	25	80	8.64	12
	RRS950388	ROCKWOOL™ Rainscreen SL950 1200 x 600 x 38mm 8/PAC	1.10	38	80	5.76	12
	RRS950506	ROCKWOOL™ Rainscreen SL950 1200 x 600 x 50mm 6/PAC	1.45	50	80	4.32	12
	RRS950754	ROCKWOOL™ Rainscreen SL950 1200 x 600 x 75mm 4/PAC	2.15	75	80	2.88	12
	RRS9501003	ROCKWOOL™ Rainscreen SL950 1200 x 600 x 100mm 3/PAC	2.85	100	80	2.16	12

OTHER SIZES/THICKNESSES ARE AVAILABLE ON REQUEST. PLEASE CONTACT THE FAIRVIEW TEAM FOR MORE INFORMATION

STRYÜM SOLID ALUMINIUM INTERLOCKING FACADE SYSTEM

Stryüm is a premium and versatile interlocking aluminium facade system, engineered to provide exceptional performance and aesthetic flexibility. This innovative facade solution has been rigorously tested as a complete system, meeting and exceeding local building regulations and standards. Backed by CodeMark certification, Stryüm assures architects and builders that it is a trusted, high-quality solution for a variety of architectural projects.

All Stryüm profiles are made of solid aluminium moulded to form the interlocking panels. The NCC 2022 C2D10 6(e) highlights the use of prefinished cladding for which Stryüm is compliant, having been fully tested as required to AS1530.1, AS1530.3 and AS4284.

In addition to its robust design, Stryüm is offered in a wide range of premium solid colours, allowing for customisation to suit any architectural vision. The system is also offered with woodgrain finishes featuring a powder-on-powder coating process, utilising the advanced Ezy HD2 coating technology. This high performance coating provides superior resistance to weathering, UV degradation and mechanical wear, ensuring the facade maintains its visual appeal and structural integrity for years to come. With the Stryüm system, you can trust that you're investing in a facade solution that delivers exceptional quality, durability and an enduring aesthetic appeal.

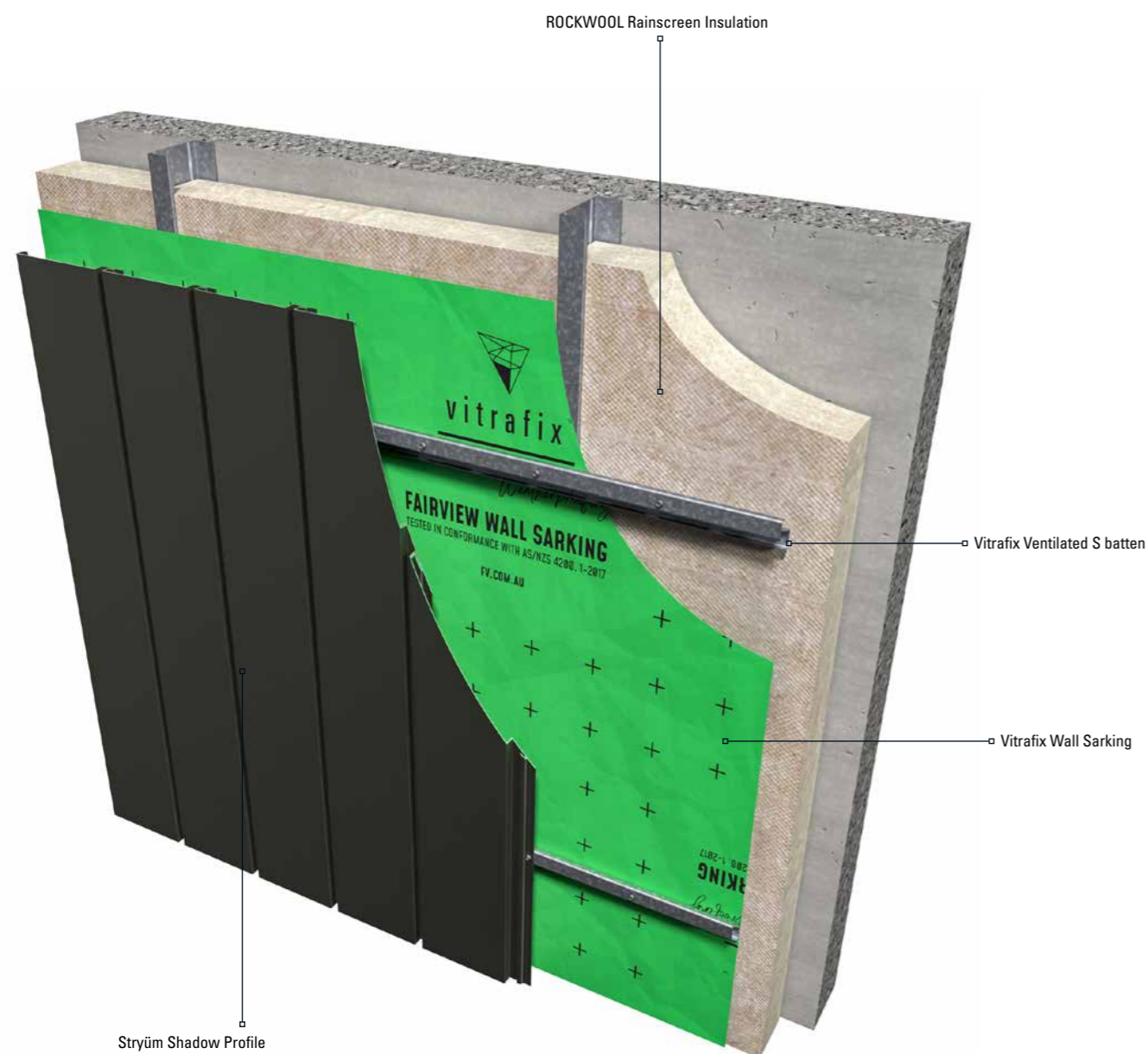

STRYÜM®

NON-COMBUSTIBLE ALUMINIUM FAÇADE / MANUFACTURED BY FAIRVIEW

STRYÜM TESTING AND COMPLIANCE

Fairview's Stryüm interlocking solid aluminium facade system has been intensively tested to ensure durability, strength and compliance to the Building Code of Australia. The following testing and compliance assessments have been completed for Stryüm:

AUSTRALIAN TEST STANDARD	TEST NAME
AS 15030.1	Combustibility Test for Materials
AS 1530.3	Simultaneous Determination of Ignitability, Flame Propagation, Heat Release and Smoke Release
AS 3939	Bushfire Compliance Assessment
AS 1170.0	Structural Design Actions – Part 0: General Principles
AS 1170.1	Structural Design Actions – Part 1: Permanent, Imposed and Other Actions
AS 1170.2	Structural Design Actions – Part 2: Wind Actions
AS 1562.1	Design and Installation of Sheet Roof and Wall Cladding – Part 1: Metal
AS 1664.1	Aluminium Structures – Part 1: Limit State Design
AS 4284	Testing of Building Facades
AS 4600	Cold-formed Steel Structures
AS 4040.3	Wind Loads for Cyclone Regions Tests

1. CYCLONIC WING LOAD TESTING

Stryüm has been rigorously tested to withstand extreme wind loads in cyclonic regions (AS4040.3-1992 Wind Loads for Cyclone Regions Tests), showcasing its remarkable strength and durability. Designed to endure the intense pressures generated by high-velocity winds, Stryüm has undergone a series of simulations that replicate the severe conditions experienced during cyclones. These tests confirm that Stryüm can resist wind forces far beyond typical building materials, maintaining its structural integrity even under the most challenging conditions.

Serviceability Limit State Pressure (P_s): 2.18 kPa.

Ultimate Limit State Pressure (P_u): -7.96 kPa.

*Contact the Fairview team for a copy of the full report.

2. QUALITY COATING FOR A DURABLE LASTING FINISH

Stryüm interlocking solid aluminium facade panels are offered in solid or woodgrain colours. The range of solid colours are made using quality powders from Dulux and Interpon, ensuring a long lasting finish that will maintain its aesthetic appeal for many years.

The range of woodgrain finishes are made using the unique ezy HD2 finish that achieves a realistic natural wood effect coating using a powder on powder process. The result achieves a high-definition wood grain effect with a highly durable finish. This ensures confidence behind the 15-year warranty offered by Fairview.

ezy
HD²

3. WALL SARKING

Stryüm interlocking solid aluminium facade system is offered with the Fairview Vitrafix range of weatherproof membranes. Vitrafix Wall Sarking, Vitrafix Wall Sarking Ultra and Pro Clima Solitex Extasana have been tested to ensure compliance to the Building Code of Australia requirements.

BREATHABLE MEMBRANES DATA

		PROCLIMA SOLITEX EXTASANA	FAIRVIEW WALL SARKING VWS50	FAIRVIEW WALL SARKING ULTRA [REINFORCED] VWSU30
AS/NZS 4201.1-1994	Resistance to Dry Delamination	N/A	Pass	Pass
AS/NZS 4201.2-1994	Resistance to Wet Delamination	N/A	Pass	Pass
AS/NZS 4201.3-1994	Shrinkage	0.00%	0.002	0.002
AS1301.448s-2019	Tensile Strength - Mean (MD)	4.8 kN/m	4.3 kN/m	7.9 kN/m
	Tensile Strength - Mean (LD)	3.7 kN/m	2.7 kN/m	8.7 kN/m
ASNZS 4200.1-2017 Clause 5.3.2.3	Edge Tear Resistance - Mean (MD)	251N	210N	419 N
	Edge Tear Resistance - Mean (LD)	188N	140N	388 N
AS2001.2.19-1988	Bursting Force - Mean	>200N	258N	522N
AS/NZS 4201.5.1994	Emittance	NN	Non-Reflective	Non-Reflective
ASTM E96-2016	Water Vapour Transmission	Class 4	Class 4	Class 4
AS/NZS 4201.4-1994	Resistance to Water Penetration	Water Barrier (Pass)	Water Barrier (Pass)	Water Barrier (Pass)
AS/NZS 3100-2017	Surface Resistivity	Electrically Non-Cond.	Electrically Non-Cond.	Electrically Non-Cond.
AS 1530.2-1993	Flammability Index	<5	1 (Low)	4 (Low)
Thickness	Nominal Thickness	0.60mm	0.50mm	0.70mm
UV Resistance	Prior to being overlaid	180 Days	3 months	6 months
Warranty		10 years	12 years	15 years

4. ROCKWOOL INSULATION

ROCKWOOL Rainscreen is a stone wool insulation developed specifically for use within ventilated cladding systems. Fairview has selected a range of Rockwool insulation products to suit most building applications. This includes:



ROCKWOOL RAINSCREEN SL950/SL960 PRODUCT SPECIFICATION

R-VALUE M2K/W	THICKNESS (MM)	WIDTH (MM)	LENGTH (MM)	# PIECES PER PACK	AREA PER PACK (M2)
0.75	25	600	1200	12	4.32
1.45	50	600	1200	6	4.32
2.20	75	600	1200	4	2.16
2.95	100	600	1200	3	2.16

5. SUB-FRAMING TESTING FOR COMPLIANCE

In order to ensure compliance and durability, the coil used to produce all Fairview Vitrafix Top Hats is tested in a NATA accredited test lab before being rolled into top hats. This testing confirms compliance to AS1397.

SAMPLE NO.	METALLIC COATING DESIGNATION	MEASURED SINGLE SPOT TOTAL COATING MASS BOTH SIDES [G/M²]	AS 1397 TABLE 3.1 MIN. COATING MASS REQUIREMENT [G/M²]	MEASURED BASE METAL THICKNESS [MM]	AS/NZS 1365 TABLE 5.1 THICKNESS TOLERANCES [MM]
1	Z275	310	250	1.14	1.15 ± 0.05
2	Z275	310	250	1.15	1.15 ± 0.05
3	Z275	265	250	1.14	1.15 ± 0.05
4	Z275	265	250	1.14	1.15 ± 0.05
5	Z275	255	250	1.14	1.15 ± 0.05
6	Z275	270	250	1.14	1.15 ± 0.05

Note: Coating mass rounded to 5 g/m², as per AS 1397:2021

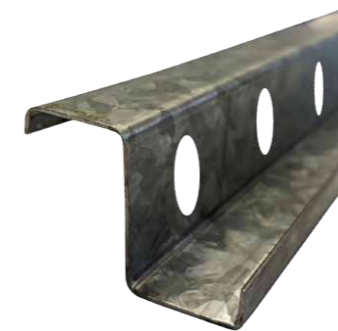

Vitrafix 35mm Galvanised Steel Perforated S Batten

Report No: 23-1094-A
Report Date: 30 October 2023

Head Office Address:
Unit 1, 15 Pickering Road
Mulgrave VIC 3170

Ph: 03 9560 2759
e: info@melbest.com.au

TENSILE TEST REPORT

In confidence to the client:
Fairview
18 - 20 Donald Street
Lithgow NSW 2790

Date of Testing: 26 October 2023
Specimen Description: Galvanised Steel Coil Samples
Testing Machine: Insight 300kN MT-3003 Grade A
Strain Device: Epsilon 50mm Extensometer MT-1238 0.001mm

SPECIMEN DETAILS:

	1	2	3	4	5	6
Specimen I.D:	HR2301 507201	HR2301 507202	HR2301 507203	HR2301 507301	HR2301 507302	HR2301 507303
Thickness:	1.14	1.15	1.14	1.14	1.14	1.14
Width:	12.27	12.27	12.32	12.34	12.32	12.35
Area:	13.99	14.11	14.04	14.07	14.04	14.08
Gauge Length:	50	50	50	50	50	50
Parallel Length:	75	75	75	75	75	75

TENSILE PROPERTIES:

	1	2	3	4	5	6
Tensile Strength:	400	390	360	400	390	400
Lower Yield Stress:	330	310	305	325	305	320
Post Fracture Elongation:	32	28	30	30	28	36

TEST COMMENTS:
Tested and reported as a reduced-section samples in accordance with AS 1391-2020 and AS 1397-2021.

Area (S_a) computed on base metal thickness (BMT).

Tensile Strength (R_m) and Lower Yield Stress (R_{eL}) results have been rounded to the nearest 10MPa and 5MPa, respectively.

Tensile properties of the tested sample are deemed to comply with AS 1397 Table 2.3; Steel Grade Designation G300.

Authorised Signatory:
Dan Humphrey

COMMITMENT TO QUALITY, THE ENVIRONMENT AND COMPLIANCE

The Stryüm range has been engineered for quality, durability, environmental stewardship and compliance to local building requirements. This is evidenced by the industry-leading warranties, independent compliance certification. Committed to sustainability, Stryüm is 100% recyclable, offering an eco-friendly building solution.



STRYÜM SOLID ALUMINIUM INTERLOCKING FACADE SYSTEM COMPONENT LIST

SUB-FRAMING ACCESSORIES

CODE	NAME	DESCRIPTION	UNIT QUANTITY
		Stryüm Interlocking Cladding Panel	LM
		Solid aluminium interlocking panels available in 10 profiles, each with a standard length of 6.5m and varying thicknesses from 1.8mm to 3.5mm. Custom sizes and profiles are available upon request, subject to MOQs.	
S2535PS	35mm Steel S Batten Perforated 2.9m	S Batten serves as a steel substrate for the Stryüm panels. The new S Batten perforated side wall keeps cavity ventilated and prevents moisture pooling in horizontal application. Linear Panel Grade: G550 Thickness: 1.15 BMT Coating: Z275	1
		S BATTEN - Ø 20 MM HOLES WITH 110MM CENTRE SPACINGS	
S2535PL	35mm Steel S Batten Perforated 5.8m	S Batten serves as a steel substrate for the Stryüm panels. The new S Batten perforated side wall keeps cavity ventilated and prevents moisture pooling in horizontal application. Linear Panel Grade: G550 Thickness: 1.15 BMT Coating: Z275	1
		S BATTEN - Ø 20 MM HOLES WITH 110MM CENTRE SPACINGS	
T5015S	15mm Steel Top Hat 2.9m	Galvanised Top Hat used as cladding substrate. Grade: G2 Steel Coating: Z 275 Thickness: 1.15BMT	1
T5015L	15mm Steel Top Hat 5.8m	Galvanised Top Hat used as cladding substrate. Grade: G2 Steel Coating: Z 275 Thickness: 1.15BMT	1
T5024S	24mm Steel Top Hat 2.9m	Galvanised Top Hat used as cladding substrate. Grade: G2 Steel Coating: Z 275 Thickness: 1.15BMT	1

SUB-FRAMING ACCESSORIES

CODE	NAME	DESCRIPTION	UNIT QUANTITY
T5024L	24mm Steel Top Hat 5.8m	Galvanised Top Hat used as cladding substrate. Grade: G2 Steel Coating: Z 275 Thickness: 1.15BMT	1
T5024PS	24mm Steel Top Hat Perforated 2.9m	Galvanised Top Hat used as cladding substrate. Grade: G2 Steel Coating: Z 275 Thickness: 1.15BMT	1
		50X24X20 TOP HAT - DIA 12 MM WITH 44 PITCH	
T5024PL	24mm Steel Top Hat Perforated 5.8m	Galvanised Top Hat used as cladding substrate. Grade: G2 Steel Coating: Z 275 Thickness: 1.15BMT	1
		50X24X20 TOP HAT - DIA 12 MM WITH 44 PITCH	
T5035S	35mm Steel Top Hat 2.9m	Galvanised Top Hat used as cladding substrate. Grade: G2 Steel Coating: Z 275 Thickness: 1.15BMT	1
T5035L	35mm Steel Top Hat 5.8m	Galvanised Top Hat used as cladding substrate. Grade: G2 Steel Coating: Z 275 Thickness: 1.15BMT	1
T5035PS	35mm Steel Top Hat Perforated 2.9m	Galvanised Top Hat used as cladding substrate. Grade: G2 Steel Coating: Z 275 Thickness: 1.15BMT	1
		50X35X20 TOP HAT - DIA 20 MM WITH 72 PITCH	
T5035PL	35mm Steel Top Hat Perforated 5.8m	Galvanised Top Hat used as cladding substrate. Grade: G2 Steel Coating: Z 275 Thickness: 1.15BMT	1
		50X35X20 TOP HAT - DIA 20 MM WITH 72 PITCH	

*For projects in cyclonic areas, please contact a FV product specialist.



TRIMS - MAIN PROFILES

DESCRIPTION	CODE	DIAGRAM
Shadow 160	SH160	
Shadow 200	SH200	
Shadow 300	SH300	
Seam 260	SE260	
Step 250	ST250	

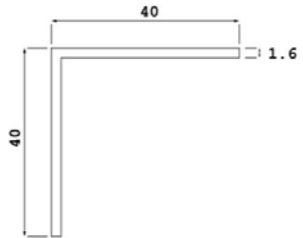
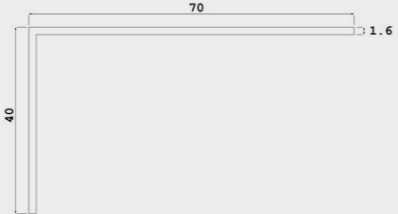
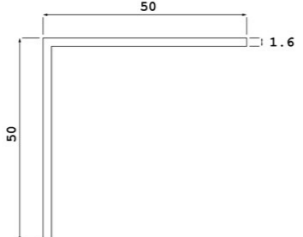
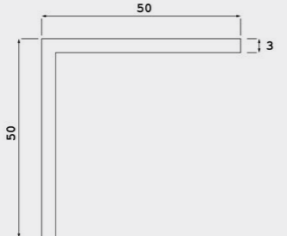

UNIVERSAL TRIMS

DESCRIPTION	CODE	DIAGRAM	USED ON
Stop End (Two-Piece)			All profiles
Stop End Male	TRM0201a		All profiles
Stop End Female	TRM0201b		All profiles
20x20x1.6 Angle	TRM0501		All profiles
20x40x1.6 Angle	TRM0502		All profiles
20x70x1.6 Angle	TRM0503		All profiles

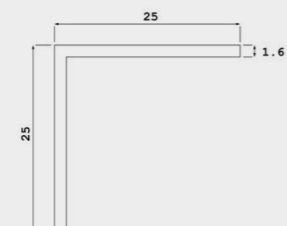
UNIVERSAL TRIMS

DESCRIPTION	CODE	DIAGRAM	USED ON
40x40x1.6 Angle	TRM0201b		All profiles
40x70x1.6 Angle	TRM0505		All profiles
50x50x1.6 Angle	TRM0506		All profiles
50x50x3 Angle	TRM0507		All profiles
25x70x1.6 Angle	TRM0508		All profiles
25x25x1.6 Angle	TRM0509		All profiles

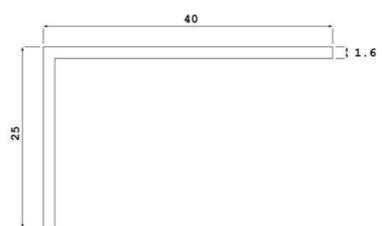
UNIVERSAL TRIMS

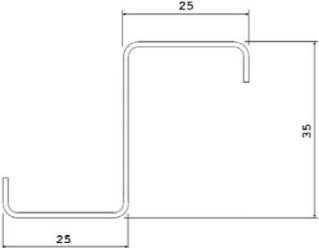
DESCRIPTION	CODE	DIAGRAM	USED ON
25x40x1.6 Angle	TRM0510		All profiles
50x125x3 Angle	TRM0511		All profiles
Stryüm S Section	TRM0901		All profiles

SHADOW TRIMS

DESCRIPTION	CODE	DIAGRAM	USED ON
Shadow Starter Strip	TRM1101		Shadow 160 Shadow 200 Shadow 300
Shadow Vertical Internal Shadowline Corner (Two-Piece)			Shadow 160 Shadow 200 Shadow 300
Shadow Vertical Internal Shadowline Corner (Male)	TRM1301a		Shadow 160 Shadow 200 Shadow 300
Shadow Vertical Internal Shadowline Corner (Female)	TRM1301b		Shadow 160 Shadow 200 Shadow 300
Shadow Vertical Internal Cap Corner (Two-Piece)			Shadow 160 Shadow 200 Shadow 300
Shadow Vertical Internal Cap Corner (Male)	TRM1302a		Shadow 160 Shadow 200 Shadow 300

SHADOW TRIMS

DESCRIPTION	CODE	DIAGRAM	USED ON
Shadow Vertical Internal Cap Corner (Female)	TRM1302b		Shadow 160 Shadow 200 Shadow 300
Shadow W Section	TRM1303		Shadow 160 Shadow 200 Shadow 300
Shadow Box External Corner	TRM1401		Shadow 160 Shadow 200 Shadow 300
Shadow Vertical External Shadowline Corner (Two-Piece)			Shadow 160 Shadow 200 Shadow 300
Shadow Vertical External Shadowline Corner (Male)	TRM1403a		Shadow 160 Shadow 200 Shadow 300
Shadow Vertical External Shadowline Corner (Female)	TRM1301b		Shadow 160 Shadow 200 Shadow 300

SHADOW TRIMS

DESCRIPTION	CODE	DIAGRAM	USED ON
Shadow Vertical External Cover Corner (Two-Piece)			Shadow 160 Shadow 200 Shadow 300
Shadow Vertical External Cover Corner (Male)	TRM1404a		Shadow 160 Shadow 200 Shadow 300
Shadow Vertical External Cover Corner (Female)	TRM1404b		Shadow 160 Shadow 200 Shadow 300
Shadow X Section	TRM1405		Shadow 160 Shadow 200 Shadow 300

SEAM TRIMS





DESCRIPTION	CODE	DIAGRAM	USED ON
Seam Starter Strip	TRM4101		Seam 260
Seam Foot Mould	TRM4202		Seam 260
Seam W Section	TRM4301		Seam 260
Seam External Corner	TRM4401		Seam 260

MEMBRANES

	CODE	NAME	DESCRIPTION	UNIT QUANTITY
	VWS50	Vitrafix Wall Sarking 1500mm x 50m Roll	Vitrafix Wall Sarking is a Class 4 vapour permeable membrane and an effective water barrier. With a 12-year warranty, it can withstand direct UV exposure for up to 3 months.	1 Roll
	VWSU30	Vitrafix Wall Sarking Ultra 1500mm x 30m Roll	Vitrafix Wall Sarking Ultra is a Class 4, heavy duty vapour permeable membrane and an effective water barrier. With a 15-year warranty, it can withstand direct UV exposure for up to 6 months and has superior strength characteristics for high wind zones.	1 Roll
	MSE150	Pro Clima Solitex Extasana Wall Membrane - 150	Pro Clima Solitex Extasana Wall Membrane is a high performance, monolithic nonporous membrane. Can be exposed to the elements for 90 days. 55m ² per roll.	1
	VWST25	Vitrafix Sarking Tape 60mm x 25m Roll	Vitrafix Sarking Tape is used for sealing overlapping joints and areas where water ingress may occur.	1 Roll
	VWSTD100	Vitrafix Double Sided Sarking Tape 60mm x 100m	Vitrafix Double Sided Sarking Tape is used to temporarily fix sarking to framing prior to installation of the facade.	1 Roll
	MTE60	Pro Clima Weathertight Sealing Tape – Tescon Extora 60mm	Weathertight Sealing Tape used to seal Pro Clima membrane. Easy to cut, thin and flexible, can be applied to cold and wet surfaces, highly UV stabilised.	10
	MTEP60	Pro Clima Corner Tape – Tescon Extora Profil 60mm	Split release paper for corner of window/door installations. Thin and flexible, can be applied to cold and wet surfaces, highly UV stabilised.	5
	MTES150	Pro Clima Sill Tape – Tescon Extoseal 150mm	Pro Clima Sill Tape - Tescon Extoseal is a one-piece stretchable sill tape, no need for corner moulds, can be applied to damp surfaces, very high adhesion on cold surfaces, no heating necessary, highly UV stabilised.	2
	VWSEPDMS	Vitrafix EPDM Sleeve – Custom	EPDM Sleeve is used to weatherproof areas where a fixture, such as a pipe etc, penetrates the sarking material. Custom sizes are available, contact the Fairview team with specific size requirements.	Please contact the Fairview team for more details

*The use of these accessories needs to be checked for compliance on your project

CAULKING

	CODE	NAME	DESCRIPTION	UNIT QUANTITY
	CAM41B	Admil Prosil 41LM – Black – 600mL Sausage	Low modulus, high movement, matt finish silicone, designed for weather sealing cladding expansion joints. 600ML sausage	20
	CAM41W	Admil Prosil 41LM – White - 600mL Sausage	Low modulus, high movement, matt finish silicone, designed for weather sealing cladding expansion joints. 600ML sausage	20
	CAM41G	Admil Prosil 41LM – Grey - 600mL Sausage	Low modulus, high movement, matt finish silicone, designed for weather sealing cladding expansion joints. 600ML sausage	20
	CBR016	Open Cell Backing Rod – 16mm x 150m	Joint filler and sealant backer for cassette installation method.	1 Roll or 20 Rolls



*The use of these accessories needs to be checked for compliance on your project

FIXINGS

	CODE	NAME	DESCRIPTION	UNIT QUANTITY
	FW1016	Self Drilling Wafer Tek Phillips 10-16 x 16mm	For fixing Z Angles to Top Hats and attaching Top Hats to framing. Class 3 Galvanised. Box 1000 Pcs.	Box of 1000
	FR48	4.8mm x 11.4mm Pop Rivets	For fixing Z Angles to aluminium facade panels. Box 1000 Pcs.	Box of 1000

*The use of these accessories needs to be checked for compliance on your project

INSULATION

	CODE	PRODUCT	R-VALUE [M ² K/W] ROUNDED TO 0.05	THICKNESS [MM]	DENSITY [KG/ M ³]	PACK M ²	PACKS/ PALLET
	RSS3502512	ROCKWOOL™ Safe'n'Silent Pro350 1200 x 600 x 25mm 12/PAC	0.70	25	60	8.64	12
	RSS350506	ROCKWOOL™ Safe'n'Silent Pro350 1200 x 600 x 50mm 6/PAC	1.45	50	60	4.32	12
	RSS350754	ROCKWOOL™ Safe'n'Silent Pro350 1200 x 600 x 75mm 4/PAC	2.15	75	60	2.88	12
	RSS3501003	ROCKWOOL™ Safe'n'Silent Pro350 1200 x 600 x 100mm 3/PAC	2.85	100	60	2.16	12
	RRS9502512	ROCKWOOL™ Rainscreen SL950 1200 x 600 x 25mm 12/PAC	0.70	25	80	8.64	12
	RRS950388	ROCKWOOL™ Rainscreen SL950 1200 x 600 x 38mm 8/PAC	1.10	38	80	5.76	12
	RRS950506	ROCKWOOL™ Rainscreen SL950 1200 x 600 x 50mm 6/PAC	1.45	50	80	4.32	12
	RRS950754	ROCKWOOL™ Rainscreen SL950 1200 x 600 x 75mm 4/PAC	2.15	75	80	2.88	12
	RRS9501003	ROCKWOOL™ Rainscreen SL950 1200 x 600 x 100mm 3/PAC	2.85	100	80	2.16	12

OTHER SIZES/THICKNESSES ARE AVAILABLE ON REQUEST. PLEASE CONTACT THE FAIRVIEW TEAM FOR MORE INFORMATION



FAIRVIEW™

DEFINING ARCHITECTURE SINCE 1988



AUSTRALIA
NEW ZEALAND
UNITED KINGDOM

SALES ENQUIRIES 1800 007 175

HELPDESK@FV.COM.AU

FV.COM.AU

VITRAFIX / JANUARY 2025