



FAIRVIEW™

DEFINING ARCHITECTURE SINCE 1983



solara™

ARCHITECTURAL SUNSCREENS / MANUFACTURED BY FAIRVIEW

PRODUCT INFORMATION

ABOUT SOLARA

Architectural battens bring rhythm, depth and shadow to a facade, elements that evolve throughout the day and subtly transform a building's character. When installed as a sunscreen, the system actively contributes to building performance. By reducing heat gain and improving facade shading, they support better thermal comfort and increased overall energy efficiency. Solara Architectural Sunscreens by Fairview delivers flexible, high-performance batten systems across two distinct material ranges, aluminium and terracotta. Each range offers its own aesthetic and material advantages, allowing designers to explore diverse expressions across a wide variety of architectural contexts.

Solara Aluminium provides an expansive spectrum of colours and finishes, from virtually unlimited powder-coated selections to the refined metallic depth of anodised surfaces. EzyHD2 woodgrain coatings add the warmth and biophilic appeal of timber without the limitations of natural wood, delivering durability, consistency and low maintenance.

Solara Terracotta offers material richness through organic fired colours, glazes and textured finishes. From earthy to bespoke, the range supports both grounded and refined architectural outcomes while maintaining a sense of authenticity and timeless appeal.

Solara battens support concealed or exposed fixing options and can be installed vertically or horizontally in continuous, spaced or patterned layouts. This flexibility gives designers precise control over shadow, scale and surface expression.

Solara simplifies the entire project journey designed to integrate with our range of facades. One supplier, one order and one coordinated set of drawings reduces complexity and eliminates the need for additional supplier relationships, streamlining delivery from design to installation. Solara meets National Construction Code requirements and is backed by industry-leading warranties and expertise, delivering straightforward specification and enduring architectural impact.



KEY FEATURES



ALUMINIUM AND TERRACOTTA

A comprehensive batten offering featuring one of the broadest palettes and material selections on the market, supporting diverse architectural outcomes across both aluminium and terracotta.



SEAMLESS FACADE INTEGRATION

Solara is the only batten system designed to integrate seamlessly within a complete Fairview facade specification. Solara can be colour and finish matched to the Fairview facade range including Stryum, Vitradual, Vitracore G2 and Clayton, enabling a cohesive, fully integrated facade specification through a single system.



SIMPLIFIED SPECIFICATION AND PROCUREMENT

One supplier, one order and one coordinated set of drawings reduces complexity and eliminates the need for additional supplier relationships, streamlining project delivery from specification through to installation.



EASY INSTALLATION & LOW MAINTENANCE

Solara battens can be cut and installed onsite using standard tools, reducing lead times and installation costs. Once installed, the system requires minimal maintenance while retaining its appearance and performance over time.



ENERGY EFFICIENT

Solara architectural sunscreens help reduce heat gain and improve facade shading, supporting better thermal comfort and increased overall building energy efficiency.



EXPERT SUPPORT

Solara is designed to meet National Construction Code requirements and is supported by the same compliance rigour, engineering expertise and technical documentation as the broader Fairview facade range.

APPLICATIONS

Solara sunscreens have been designed for use in a wide variety of architectural and structural applications, including:

- Commercial facades and feature walls
- Shopping centres and retail developments
- Office buildings and institutional projects
- Residential homes, townhouses and apartment buildings
- Sun-shading, screening and ventilation panels
- Interior decorative walls and ceilings
- Landscaping elements such as fences, gates and pergolas

Solara sunscreens provide excellent resistance to corrosion, weathering and wind loads, making them suitable for both interior and exposed external applications, including coastal environments when the appropriate finish is specified.

It remains the responsibility of the building designer to verify that Solara is suitable for the specific requirements of the project.

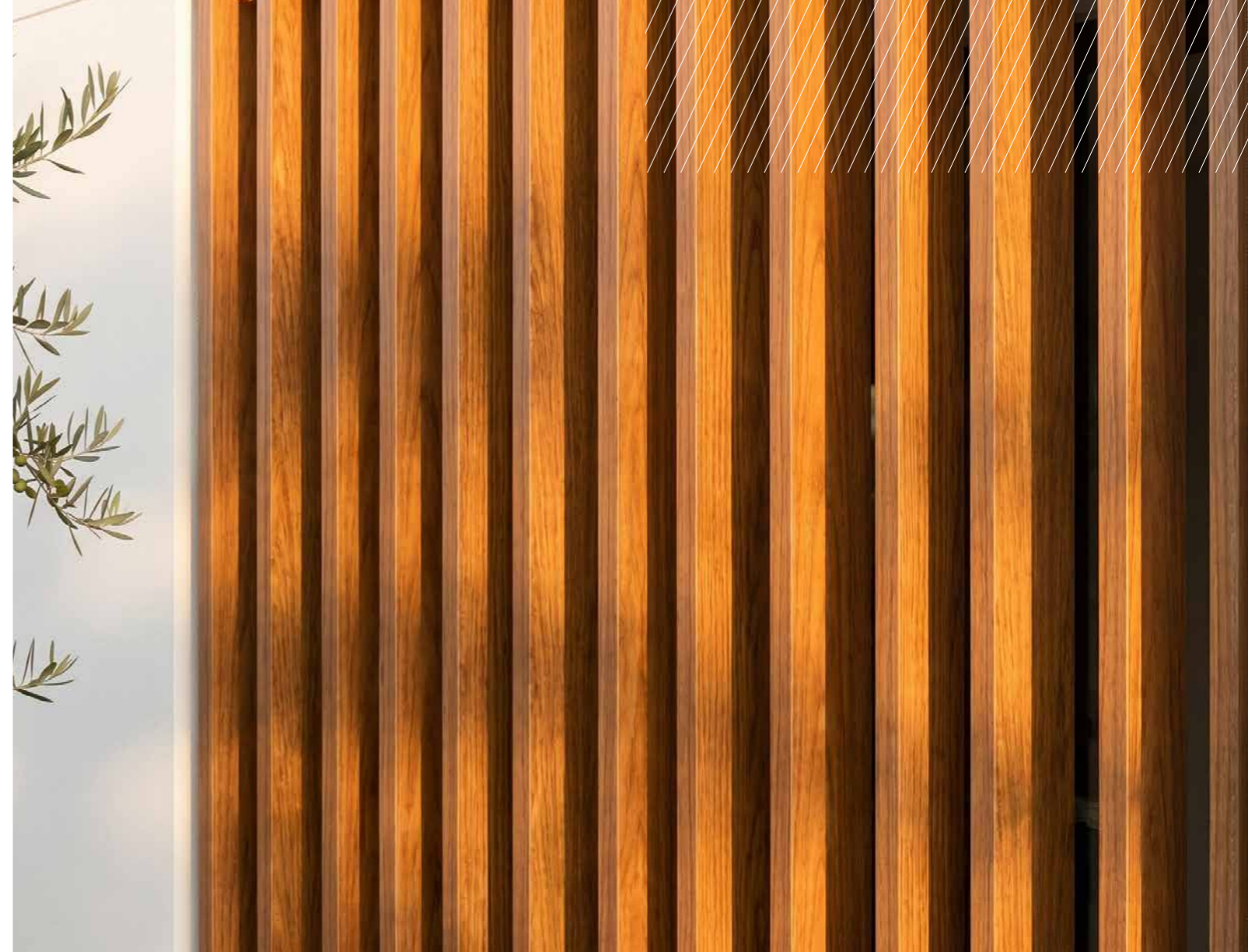

SOLARA TERRACOTTA

Product	Terracotta batten system
Finish	Available in range of standard colours and specialised glazed and textured finishes
Length	300-1500mm
Fixing System	Profile-specific installation comes fully assembled ready to be installed
Warranty	15-year warranty, subject to standard terms and conditions

KEY BENEFITS

COLOURS

Solara terracotta battens offers a palette of colours and textures that cannot be achieved by aluminium. Available in a variety of natural fired colours, pigments, oxides and glazes to achieve any desired colour, tone or finish. The firing process locks the colour into the batten, ensuring your design will last for the life of the building.

TEXTURES & PROFILES

Solara terracotta is offered in a diverse range of shapes unique to the range, allowing designers to play with different shadow effects and forms.

DURABLE & LONG LASTING

Terracotta's natural composition makes it inherently resistant to harsh weather conditions, robust against damage, offering a life expectancy that far exceeds other materials.

MAINTENANCE

The terracotta surface is anti-static and therefore dust resistant. If the surface is dusty, it is easily washed off by rain. This self-cleaning function can reduce the cleaning and maintenance costs, especially for high-rise buildings.

THERMAL EFFICIENCY

Terracotta's high thermal mass buffers against external temperature fluctuations, absorbing and slowly releasing heat to deliver stable, consistent thermal performance across both interior and exterior applications.

SAFE, ECO-FRIENDLY & SUSTAINABLE

Terracotta is an environmentally friendly material made from 100% clay that can be easily recycled, repurposed into other uses or broken down quickly and put back into the Earth, reducing the amount of waste that ends up in landfill.



TERRACOTTA PROFILES

SQUARE

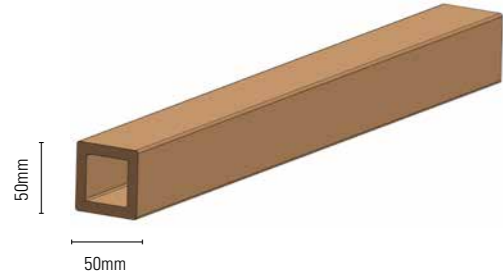

CAMBERED

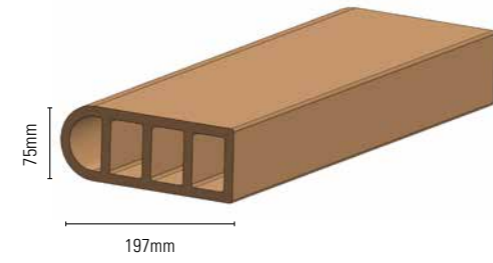

CIRCULAR

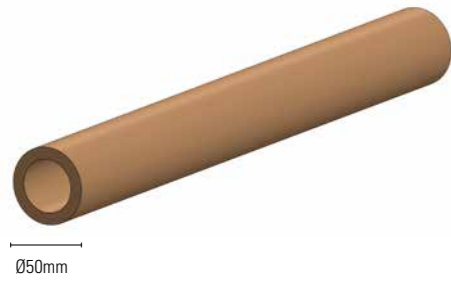

LOUVER

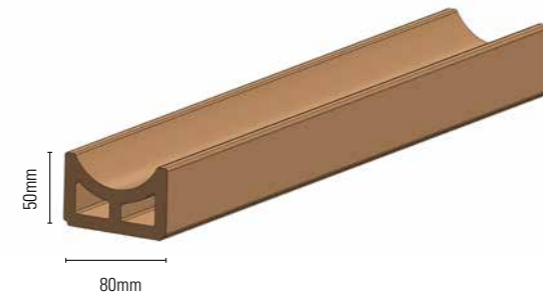

RECTANGULAR

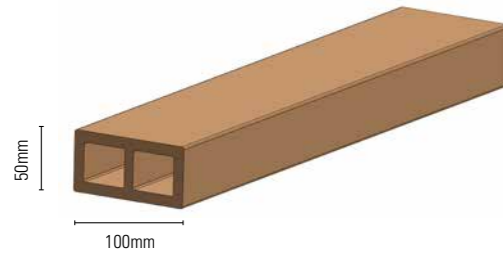

LAMERA

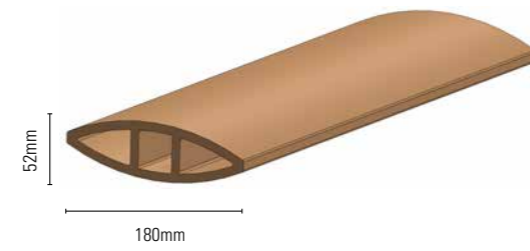

RECTANGULAR WIDE

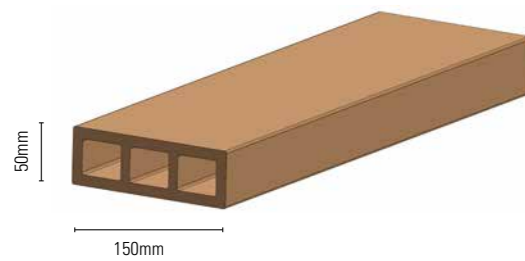

ARC

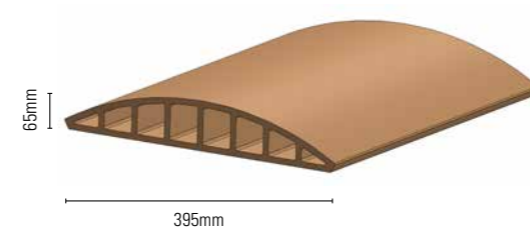

STANDARD COLOURS

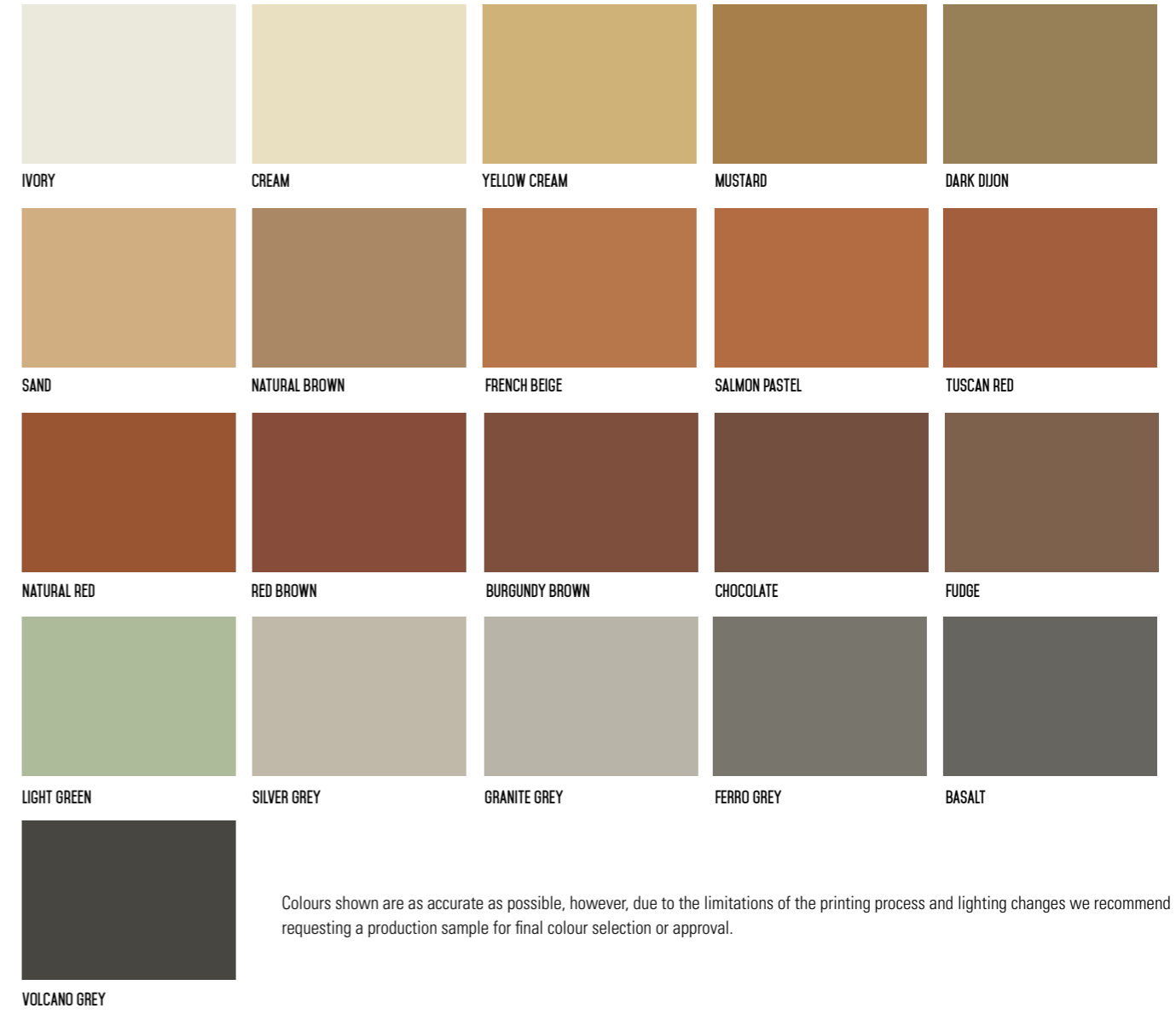

SPECIALISED FINISHES



SOLARA ALUMINIUM

Product	Aluminium batten system – available in clip-on and solid box extrusion profiles
Finish	Wide range of powder-coated, anodised and textured woodgrain finishes
Length	Up to 5800mm
Fixing System	Clip-on and screw fixing options for straightforward installation
Warranty	15-year warranty, subject to standard terms and conditions

KEY BENEFITS

CUSTOM FINISHES & COLOURS

Available in powder-coated, anodised or woodgrain finishes, Solara aluminium battens can be tailored to achieve any design intent, providing long-lasting aesthetics.

LIGHTWEIGHT & STRONG

Solara aluminium battens provide high strength-to-weight ratio, making handling and installation easier without compromising structural performance.

INSTALLATION VERSATILITY

Solara aluminium battens offer a wide range of fixing and installation methods, providing design flexibility to achieve both aesthetic outcomes and compliance requirements across a diverse range of applications.

SEAMLESS LINEAR DESIGN

Solara aluminium battens are available in long profile lengths, minimising joints for a clean, continuous linear aesthetic.

CORROSION RESISTANT

Made from durable aluminium, Solara aluminium battens resist rust and corrosion, making them ideal for both indoor and outdoor applications.

RECYCLABLE

Aluminium is 100% recyclable without loss of quality, making Solara aluminium battens a sustainable choice for green building projects.



ALUMINIUM PROFILES

TWO PIECE CLIP-ON

50x25mm, 50x50mm, 50x100mm, 50x150mm, 50x200mm

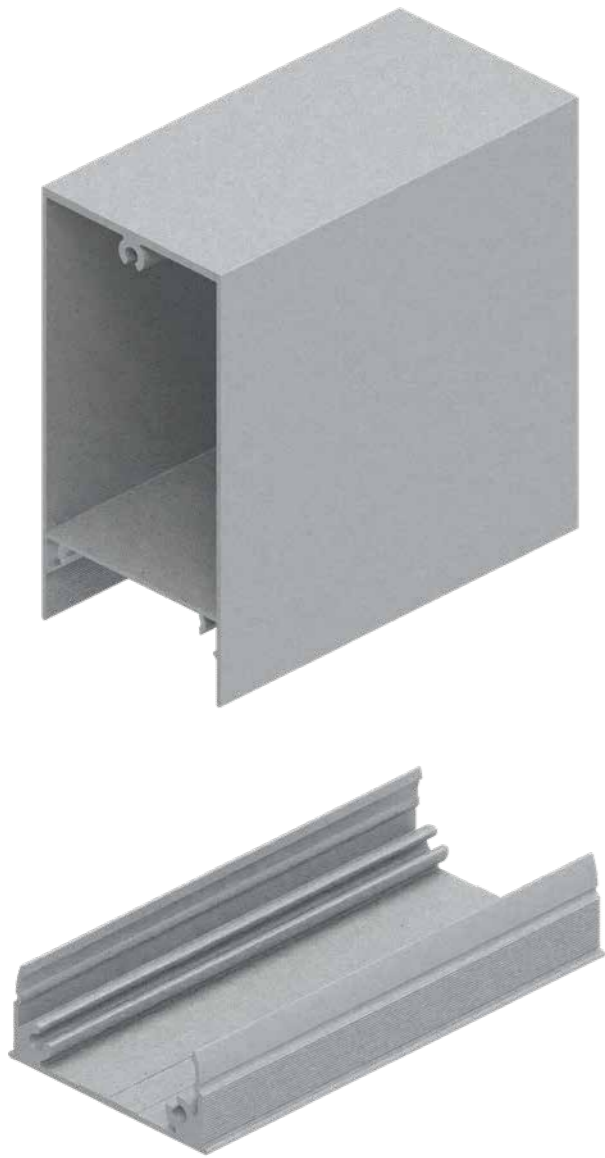

SINGLE PIECE SOLID BOX EXTRUSION

50x50mm, 50x100mm, 50x150mm, 50x200mm, 50x250mm



POWDER-COATED COLOURS

STANDARD

			
PEARL WHITE Matt YA278A	PEARL WHITE Gloss YA075A	APPLIANCE WHITE Satin YA196A	SURFMIST Matt YA236A
			
LUNAR GREY Matt YP273A	DRIFTWOOD Matt YL258A	SILVER PEARL Matt YY230A	ANODIC NATURAL Matt YY223A
			
CITI PEARL Matt YY245A	LUXE BRONZE PEARL Matt YY255A	SCINTILLATING CHAMPAGNE Matt YW26FC	CHAMPAGNE PEARL Matt YY276A
			
NOBEL SILVER PEARL Satin YY136A	PEWTER PEARL Satin YY124A	ETERNAL SILVER Satin YW100C	GREY Satin YP174A
			
TIMBERLAND Matt YP275A	TIMBERLAND Satin YP175A	TITANIUM PEARL Matt YY263A	TITANIUM PEARL Satin YY163A
			
MONUMENT® Matt YL264A	MONUMENT® MKII Satin YP182A	CHARCOAL Matt YL238A	CHARCOAL Satin YP166A

Colours shown are as accurate as possible, however, due to the limitations of the printing process and lighting changes we recommend requesting a production sample for final colour selection or approval. For further details or to request a sample, please email: helpdesk@fv.com.au or call 1800 007 175.

POWDER-COATED COLOURS

STANDARD



DARK GREY YP278A
Matt



CHARCOAL PEARL YY237A
Matt



EBONY YN201A
Matt



BLACK YN167A
Satin



ENDURA BRONZE YY248A
Matt



ASTEROID PEARL YY270A
Matt



BRONZE PEARL YY225A
Matt

TEXTURED



SABLE™ BRILLIANCE YY377A
Texture



SABLE™ BASS YY397A
Texture



SABLE™ MEDIUM BRONZE YY366A
Texture

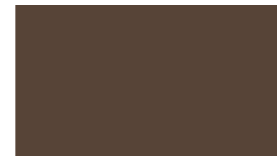

SABLE™ CORE TEN™ YX350A
Texture

BRIGHT



BRILLIANT YELLOW YE087A
Gloss



LYCRA STRIP YK063A
Gloss



VIPER GREEN YK051A
Gloss



SHAMROCK GREEN YK043A
Gloss



SENSATION YF049A
Gloss



LOBSTER YG154A
Satin



BONDI BLUE YJ046A
Matt



JAYBIRD YJ175A
Satin

Colours shown are as accurate as possible, however, due to the limitations of the printing process and lighting changes we recommend requesting a production sample for final colour selection or approval. For further details or to request a sample, please email: helpdesk@fv.com.au or call 1800 007 175.

POWDER-COATED COLOURS

FLAT MATT

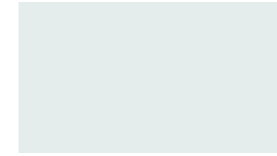

WHITE YA25BA
Flat Matt

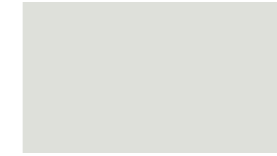

LINEN YY28PA
Flat Matt



NATURAL SHIMMER YY25AA
Flat Matt



CHAMPAGNE SHIMMER YY24NA
Flat Matt



SUNSTONE BRONZE YY21BA
Flat Matt



PURE GOLD YY22BA
Flat Matt



GOLDEN TOUCH PEARL YY25BA
Flat Matt



BRILLIANCE YY23TA
Flat Matt



DARK BRONZE YY20BA
Flat Matt



MONUMENT YP229A
Flat Matt



VINTAGE SILVER YY22NA
Flat Matt



BLACK INK YN21BA
Flat Matt

Colours shown are as accurate as possible, however, due to the limitations of the printing process and lighting changes we recommend requesting a production sample for final colour selection or approval. For further details or to request a sample, please email: helpdesk@fv.com.au or call 1800 007 175.

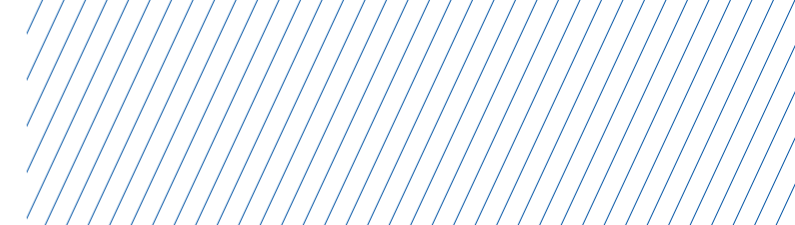

ANODISED COLOURS

STANDARD



			
STAINLESS GREY S9211	SILVER GREY S9221	SLATE GREY S9229	CHARCOAL GREY S9260
			
SPANISH SILVER S9102	AZURE BLUE S9810	REEF BLUE S9830	STEEL BLUE S9850
			
GUM TIP S9710	SAGE GREEN S9725	CAMOUFLAUGE GREEN S9740	WILDERNESS GREEN S9760
			
SANDSTONE S9605	QUARRY BIEGE S9615	PALE BRONZE S9630	LIGHT BRONZE S9431
			
MEDIUM BRONZE S9441	DARK BRONZE S9485	ESPRESSO BRONZE S9490	CHAMPAGNE S9910
			
DOESKIN S9920	ORIENTAL S9930	VENETIAN S9940	

WOODGRAIN COLOURS

STANDARD

			
INFINITY ASH S8100	WHITE OAK S8910	GREY OAK S8220	BLONDE ASH S8907
			
AUSTRALIAN ASH S8908	AMERICAN OAK S8680	GOLDEN OAK S8431	RED OAK S8434
			
WESTERN RED OAK S8515	ROYAL OAK S8453	BROWN OAK S8456	VOLCANO OAK S8470
			
EBONY ASH S8909	CHARRED CEDAR S8911		

CUSTOM

	
ASHBOX S8906	TASMANIAN OAK S8903

Colours shown are as accurate as possible, however, due to the limitations of the printing process and lighting changes we recommend requesting a production sample for final colour selection or approval. For further details or to request a sample, please email: helpdesk@fv.com.au or call 1800 007 175.

Colours shown are as accurate as possible, however, due to the limitations of the printing process and lighting changes we recommend requesting a production sample for final colour selection or approval. For further details or to request a sample, please email: helpdesk@fv.com.au or call 1800 007 175.

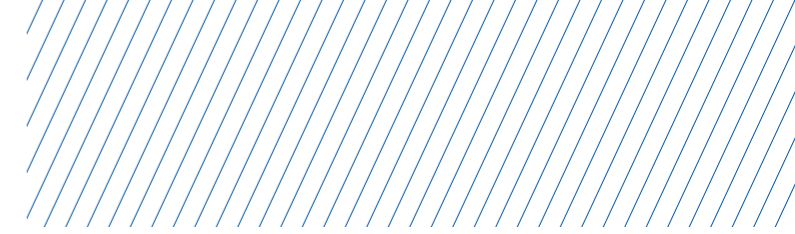

WARRANTY

Solara architectural sunscreens are an incredibly durable building material when used in the right application and installed by licensed professionals. Solara by Fairview offers a 15-year warranty, subject to standard terms and conditions.

DISCLAIMER

While the information provided relating to Solara products is true to the tests and measures available to us, the information contained in this document is general in nature only and does not constitute project-specific building, construction or fire-safety advice. Before acting on any information in this document, you should carefully consider its appropriateness in relation to your project parameters and requirements.

Solara architectural sunscreens are deemed suitable or compliant only after approval from building and construction professionals associated with the specific project or development. If you'd like further insight about this topic, contact our team on 1800 007 175 or email helpdesk@fv.com.au. We're here to help.

For more information on the Solara range and to order samples online, visit www.fv.com.au or call 1800 007 175.

You'll also find helpful resources detailing:

- Product guides and specifications
- Installation recommendations
- Maintenance and compliance information
- All architectural details
- Finishing options and colour swatches
- Solara technical data
- Solara maintenance info
- Warranty information
- Contact information

All colours represented in all imagery have been reproduced as a guide only. For precise colour reproduction please refer to physical product samples. This brochure has been designed and printed in Australia.



FAIRVIEW™

DEFINING ARCHITECTURE SINCE 1988



SALES ENQUIRIES 1800 007 175

SALES@FV.COM.AU

FV.COM.AU

SOLARA / MAY 2026